



**ECTA**

**Fecc**  
EUROPEAN ASSOCIATION OF  
CHEMICAL DISTRIBUTORS

# Best Practice Guidelines for Safe (Un)Loading of Road Freight Vehicles, covering Technical, Behavioural and Organisational Aspects



Issue 1 November 2013



Please consider the environment before printing



**Responsible Care**<sup>®</sup>  
OUR COMMITMENT TO SUSTAINABILITY

## DISCLAIMER

This document is intended for information only and sets out guidelines for the safe (un)loading of chemical products (Bulk, Packed & Liquid). The information provided in these guidelines is provided in good faith and, while it is accurate as far as the authors are aware, no representations or warranties are made with regards to its completeness. It is not intended to be a comprehensive guide for the (un)loading of chemical products (Bulk, Packed & Liquid). No responsibility will be assumed by ECTA or other co-authors in relation to the information contained in these Guidelines.

## Table of Contents

<i>Table of Contents</i>	2
<i>Introduction</i>	3
<i>Scope and objectives</i>	3
<i>Part A: Organizational and Behavioural aspects</i>	4
1. <i>Behaviour based safety</i>	4
2. <i>Roles and responsibilities</i>	9
3. <i>SQAS and ESAD</i>	18
4. <i>Emergency response plan</i>	19
5. <i>Applicable legislation</i>	21
6. <i>Communication skills of drivers and operators</i>	22
<i>Part B: Technical aspects</i>	23
7. <i>Technical requirements (un)loading sites</i>	23
8. <i>SULID: Site (Un)Loading Information Document</i>	24
9. <i>Information, instructions and training for drivers and operators</i>	26
10. <i>Personal Protective Equipment (PPE)</i>	30
11. <i>Unloading scenario's bulk liquid</i>	33
12. <i>Couplings and hoses for bulk liquids and gasses</i>	37
<i>Contact list</i>	45
<i>Part C: Annexes</i>	46
1. <i>Annex 1: Example Risk assessment for Bulk Solids Unloading sites</i>	46
2. <i>Annex 2: Pictorial examples of Access/ Egress to the (un)loading area</i>	47
3. <i>Annex 3: Examples Behaviour Based Safety Observation reports</i>	49
4. <i>Annex 4: Roles and Tasks for load securing in Cargo Transport Units</i>	52
5. <i>Annex 5: Hierarchy and lists of applicable legislation</i>	53
6. <i>Annex 6: Best Practice Guidelines</i>	57
7. <i>Annex 7: Examples of Risks and Risk mitigation for (un)loading operations</i>	58
8. <i>Annex 8: (Un)loading expressions / list in English</i>	64
9. <i>Annex 9: Examples of pictographic loading instructions</i>	65

## Introduction

Continuous efforts to improve safety during the transport and the associated handling of chemicals are part of the overall aim to improve safety performance of both the chemical industry and the transport industry.

Statistical analysis of accidents indicates that 80% of transport-related incidents and accidents occur during loading and unloading operations. Further detailed analysis shows that in 90% of these cases, the human factor is the root cause.

It is therefore essential to increase safety during loading and unloading.

These guidelines offer best practice guidance regarding the safety of loading and unloading operations from organizational, behavioural and technical point of view.

Standardisation of processes and equipment will reduce the number and consequences of interface mismatches thus intrinsically improving the safety of the (un)loading operation and therefore the entire supply chain.

The previous version of this guideline: [Behaviour Based Safety Guidelines for the safe loading & unloading of road freight vehicles. Issue 2 March 2007](#) served our industries well in providing a clear guidance on who is to be expected to perform what task thereby largely standardising the organisational part of the (un)loading process.

That part of the guideline is a best practice now and makes its appearance again in chapter 2 [Roles and responsibilities](#) of this revised guideline with some minor additions and clarifications.

The implementation of a Behaviour Based Safety management system has proven to be very effective in reducing incidents on chemical manufacturing sites but only makes it first steps in the logistics industry today. Chapter 1: [Behaviour based safety](#) of this guideline shows the reader the industry's best practice today and is a significant development of the second chapter of the previous '[BBS guideline](#)'.

More technical best practices on standardisation of equipment (i.e. Technical requirements, PPE, couplings) and processes (i.e. SULID, info and instructions, communication) can be found in [Part B: Technical aspects](#) of the document.

In all circumstances, the applicable national or international regulations take precedence over the recommendations made in these guidelines.

The guidelines are of a voluntary nature. Individual companies may decide to apply the guidelines either in full, or partly, according to their own judgment and in light of the specific circumstances.



The writing of guidelines in itself is the subject of continuous improvement.

**This guideline is not meant to be printed** on 66 glossy pages.

The guideline contains several **cross references** and **external hyperlinks** and is designed to live its life in the virtual world.

Feedback, suggestions on broken links and updates can be sent to [vtr@cefic.be](mailto:vtr@cefic.be)

Steven Beddegenoodts, Chairman of the workgroup.

## Scope and objectives

The objective of these guidelines is to provide assistance in the prevention or elimination of unsafe conditions and situations during (un)loading operations by promoting standardisation on best practice, recognizing the need for interaction between the different parties involved.

The scope of these guidelines includes the safe loading and unloading of chemical products by operators and drivers at production sites, storage terminals, warehouses and customers, and covers the loading and unloading of liquid bulk, dry bulk as well as packed goods.

## Part A: Organizational and Behavioural aspects

A safety management system is meant to identify hazards, to control risks and to measure effectiveness of mitigating actions.

The safety management system therefore also must cover the entire (un)loading operation from gate to gate and take into account each of the subsequent chapters of this document.

These include 'Behaviour based safety', 'Roles and responsibilities', 'SQAS and ESAD', 'Emergency response plan', 'Applicable legislation' and 'Communication skills of drivers and operators'.

### 1. Behaviour based safety

Behaviour Based Safety (BBS) is a safety management practice that has originally been used in the process industry to improve the safety level on the work floor. This guideline strongly suggests application of this system to the (un)loading operation.

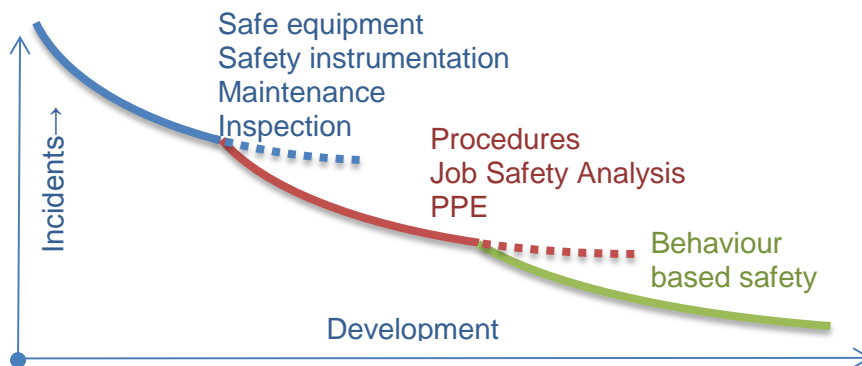

The focus of any safety management system should be to

- define /design safe equipment
- define /design safety instrumentation as a result of hazop's (Hazard and Operability Analysis), and hazan's (Hazard Analysis)
- maintain and inspect that equipment and instrumentation

to define and use

- JSA's (job safety analysis)
- work instructions derived from those JSA's
- Personal Protective Equipment

See [Technical requirements \(un\)loading sites](#) for examples of those elements.

Behaviour safety practices becomes a very important element in reducing incidents and normally follow from the first two phases in the graph above.

Key principles to this BBS process are

- the active involvement of (higher) management and
- the effective observation of the behaviour of the workers during operations.

The goal is to learn from these observations and to positively influence the future behaviour of the participants. In other words: to gradually improve the safety culture on the work floor.

During this process it is important that behaviour is being understood as not only the result of personal skill and attitude, but also as the result of the environment, the available equipment, the applicable procedures and the attitude of others.

Therefore, this process will not work without the proper training of the participants: the supervisors, the operators, the observers, the drivers etc.

Our challenge is in the fact that multiple parties are involved in the operations of the (un)loading process: supplier, (un)loading site, carrier. This is part of the implementation of a BBS program. Observations are to be shared, reported, analysed, challenged and performed together. All parties in the process have a common interest in increasing the safety level of the operations.

The next pages provide practical tools and a guideline for the implementation of a BBS program. Using the step by step approach below facilitates any organization determining the level it is at with regards to the implementation process.

The levels can be used as an evaluation tool by all parties.

### 1.1. BBS at Level 1

---

1. There is a strong safety management system in place which includes;
  - a safety policy signed by the management
  - regular safety meetings
  - safety training programs
  - involvement of all personnel to improve safety (near miss reporting system)
  - written procedures and instructions
  - regular communication of safety matters to all employees

This system is evaluated internally on a regular basis and improvement action plans are in place.

2. It is acknowledged that more than 90 % of all injuries are a result of unsafe actions, poor decisions and at risk behaviour.

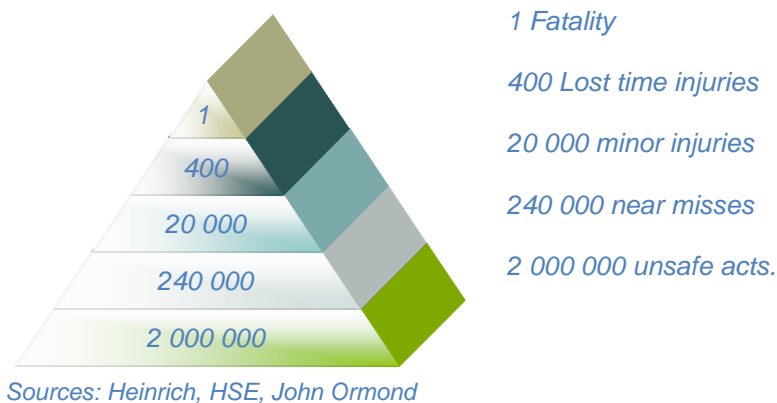

3. It is acknowledged by the management that unsafe actions, poor decisions, at risk behaviours etc. are signs that the company has a poor safety culture and that the safety culture can be improved by setting up a Behavioural Based Safety Program which involves the management and **all** employees.
4. It is acknowledged by the management that the basis for changing the safety culture is by showing their commitment and by creating a safe working environment for all employees. e.g.:
  - Give the right example (use of PPE, following procedures etc.)
  - Listen to concerns and ideas raised by employees.
  - Take immediate action when an unsafe condition, near miss etc. is reported and communicate back what actions have been taken.
  - Involve employees in improvement programs.
  - Show visible commitment to safety by being regularly on the work floor, discussing issues with employees etc.
  - Encourage a team spirit and trust between employees and management.

## 1.2. BBS at Level 2

---

= Level 1 plus the following items

1. Someone is assigned to lead the BBS program. This can be an internal or an external specialist who has been trained in BBS improvement programs.
2. Identify for all the activities, a list of critical (at risk) safe and unsafe behaviours. This can be done by using incident investigation reports, near miss reports and risk assessments.  
This is accomplished through involvement of a multi-disciplinary team of the workforce. This list will make clear to all employees what 'at risk' behaviour is, e.g.
  - Driving a forklift without adequate visibility to crossing traffic.
  - Failure to check the working conditions when issuing a Permit-To-Work (e.g. presence of flammable material when doing hot work.)
  - Failure to isolate electrical equipment before starting the job.
  - Failure to use the life line system when going on top of a truck.
  - By-passing a safety device (e.g. light cells).
3. Give training to the management and all employees on the BBS system:
  - why the system has been set up
  - the commitment of the management to make it a success
  - how the system works
  - what the expected outcome is
  - what the role of all employees is

### 1.3. BBS at Level 3

---

= Level 2 plus the following items

1. Assign people within all layers of the organization to do behavioural observation rounds. Organize training on:
  - what are 'at risk' behaviours
  - observation techniques
  - how to approach people that were observed (how to give positive reinforcement, how to coach them to change their behaviour)
  - how to report
2. Set up a system of behavioural observations:
  - Make a plan.
  - Set targets and goals.
  - Trained observers observe the work force and record 'safe' / 'at risk' behaviours.
  - Use the list of 'at risk behaviours' as guidance.
  - Give immediate feedback to the person that was observed.
  - Give positive reinforcement when safe behaviours are observed.
  - Provide coaching/ correction when at risk behaviours are observed (stop the activity when necessary), explain what could be the consequence of the unsafe behaviour.
  - Focus on safe behaviours.
  - Write a report.
3. Collect, record and analyse observation data.  
Look for trends.  
Try to understand why people behave in a certain way and what can be done to improve.
4. Communicate, on a regular basis, the observation results to all employees and all involved parties. Evaluate whether improvements are noticed. If necessary, adjust the system or look for an alternative.

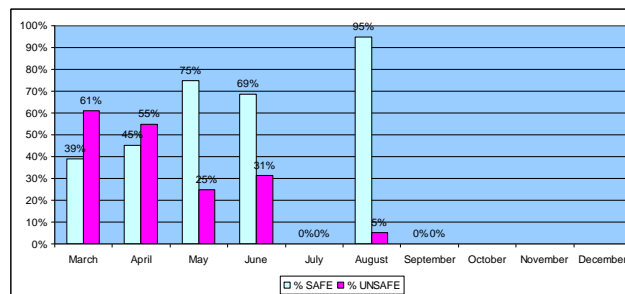

*Example of a report on the observations.*

## 1.4. BBS at Level 4

= Level 3 plus the following items

1. Use a system to analyse unsafe behaviours.  
Example: the ABC analysis.

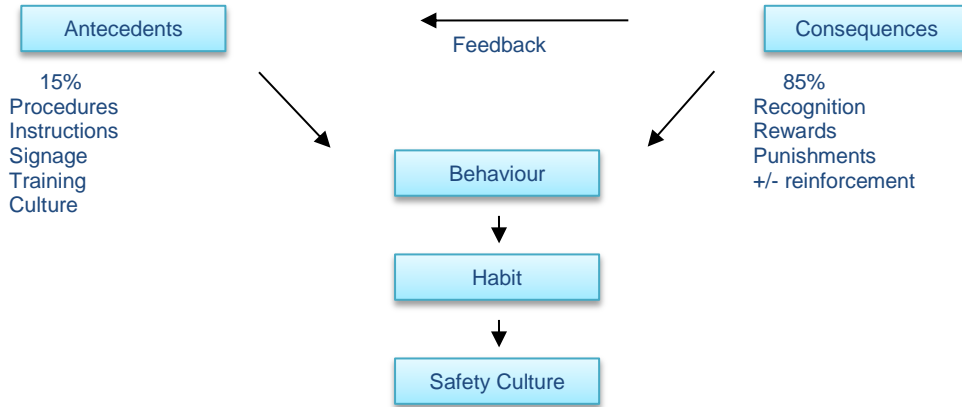

2. The change in safety culture can be measured. One option is to ask all employees to fill in a checklist before starting the program and after a certain period (e.g. 6 months);

Example:

	1	2	3	4
The managers are doing regular safety tours				
The management wants to provide a safe working environment for us				
The management is interested in the way we work and discuss with us how they can further improve our safety				
My manager wears the right PPE				
My manager appreciates that I submit proposals to improve safety				
My manager shows involvement in my personal safety				
When necessary, my manager makes available quickly the necessary means to remove unsafe situations / operations				
I am addressed by my manager when he notices that I am working unsafely				

3. There is an active BBS policy towards customers and suppliers. The BBS policy, results, achievements etc. are openly communicated to customers and suppliers and these are encouraged to join the program

In '[Annex 3: Examples Behaviour Based Safety Observation reports](#)' are generic and specific examples of Behaviour Based Safety Observation reports.



## 2. Roles and responsibilities

This chapter lists the roles and responsibilities of parties and individuals in the (un)loading operation. Any deviation from the listed partition has to be agreed upon by both parties.

### 2.1. Parties involved

Principal:	The party or parties commissioning the transport company and/or the (un)loading site.
Transport Company:	Contracted by the principal (including subcontractors, if any).
Site:	The site where the actual (un)loading takes place, including production sites, storage terminals, warehouses and customers premises.
Driver:	The person who is actually carrying out the transport.
Operator:	The site employee who is physically carrying out the (un)loading operation.

### 2.2. Responsibilities

The (un)loading site is responsible for all activities and is required to take appropriate measures so that all persons - including any from outside undertakings - engaged in on-site operations work can do so safely. This includes the entire (un)loading operation.

#### 2.2.1. Management responsibilities

The following responsibilities are essential for the management of (un)loading sites and transport companies. They should be reflected in operating procedures.

Site	Transport Company
<b>Equipment</b>	
The site management should always supply equipment that is fit for the operation to be carried out and meets all applicable legal requirements.	The Transport Company should always supply equipment that is fit for the operation to be carried out and meets all applicable legal requirements.
<b>Competence</b>	
The management of the site should ensure that operators are fit for duty and have passed successfully all the training necessary to fulfil the legislative and site requirements, in particular regarding the handling of dangerous goods.	The management of the transport company should ensure that drivers are fit for duty and have passed successfully all necessary training to fulfil the legislative requirements and site requirements, in particular regarding the transportation and handling of dangerous goods.
Please see <a href="#">'Information, instructions and training for drivers and operators'</a> .	
Operators dealing with drivers should be able to communicate in the local language and through a limited number of expressions in English.	Drivers should be able to communicate in the local language or through a limited number of expressions in English.

For details see ['Communication skills of drivers and operators'](#).

Site	Transport Company
------	-------------------

**Site instructions**

The management of the site should ensure that the site's requirements are communicated to the transport company management and that safety procedures are communicated to the drivers upon arrival. Management must promote and maintain safety awareness, particularly during product handling. The management ensures that (un)loading operations are carried out under site supervision.

The transport company will communicate the received site's requirements to all involved people.

Please see [SULID: Site \(Un\)Loading Information Document](#) for more details.

**Working at height**

The management of the site should provide safe conditions for working at height (including safe access to top of vehicles) in conformity with the applicable legislation.

The transport company must comply with the 'Working at Height' guideline.

Ref: [ECTA/CEFIC Best Practice Guidelines for the Safe Working at Height in the Chemical Logistics Supply Chain`](#)

**Product quality**

The preferred option is product acceptance on the basis of a Certificate of Analysis. Taking samples from vehicles should be avoided. If the taking of samples is required, the management of the site must ensure that samples are taken by qualified site personnel or by appointed surveyors with adequate safety precautions.

Drivers are instructed not to take product samples.

**Filling degree**

The application of ADR rule 4.3.2.2.4 (2013) should also be applied for the carriage of non-Dangerous goods.  
 4.3.2.2.4 Shells intended for the carriage of substances in the liquid state or liquefied gases or refrigerated liquefied gases, which are not divided by partitions or surge plates into sections of not more than 7 500 litres capacity, shall be filled to not less than 80% or not more than 20% of their capacity.

Site	Transport Company
<b>Cargo securing</b>	
<p>The management of the site, in cooperation with the management of the transport company,</p>	<p>The management of the transport company, in cooperation with the management of the site,</p>
<p>should ensure that the respective roles and tasks are carried out as described in <a href="#">‘Annex 4: Roles and Tasks for load securing in Cargo Transport Units’</a></p>	
<b>Non Standard Operations</b>	
<p>Non Standard operations such as</p> <ul style="list-style-type: none"> <li>• direct discharge of liquids from bulk liquid trucks or containers into drums or IBC’s</li> <li>• adding additives in bulk liquid containers prior or during loading and</li> <li>• unloading into more than one storage tank or incomplete unloading</li> </ul> <p>require the site to risk asses with the carrier prior start of operation. See <a href="#">‘Examples of risk mitigation for non-standard operations’</a> for details.</p>	
<b>Entry into confined spaces – risk of toxic/ inert gas</b>	
<p>Confined spaces (box containers, tanks, silo’s) are potentially dangerous due to the presence of substances and / or the lack of oxygen (e.g. fumigated box containers, tanks unloaded with nitrogen). Poor natural ventilation in these areas allows the build-up of high concentrations of substances which are not usually found in breathable air. Therefore NO ONE must be allowed to enter a tank/silo/container unless: The confined atmosphere has been tested by a competent person, using calibrated testing equipment. An entry permit has been issued. The safety requirements as described in the permit are adhered to.</p>	
<b>Emergency preparedness</b>	
<p>The management of the site should ensure that the necessary site safety equipment is available at the (un)loading locations, e.g. fire extinguisher(s), eye wash &amp; safety shower, first aid equipment, emergency escape routes, emergency stop, decontamination equipment, absorbent materials etc. Note that the ADR equipment carried by the driver is for on the road use only.</p>	
<b>Near Misses &amp; Incident reporting</b>	
<p>The management of the site ensures there is a procedure to report all near misses, incidents, (un)loading problems and unsafe situations or conditions, including follow-up. There should be a system in place to share information on near-misses, incidents or unsafe situations with all parties involved.</p>	<p>The management of the transport company ensures there is a procedure to report all near misses, incidents, (un)loading problems and unsafe situations or conditions, including follow-up. There should be a system in place to share information on near-misses, incidents or unsafe situations with the principal.</p>

### 2.2.2. Operational responsibilities

Continuous monitoring of the (un)loading process by operator and driver in close co-operation is essential. To this end operator and driver should be well aware of each other's responsibilities, as detailed in the following table.

In certain areas there are joint responsibilities of both operators and drivers. In these cases the same text has been repeated for both operators and drivers in the table.

In all circumstances, the applicable national or international regulations must always be complied with and take precedence over the recommendations made in these guidelines.

Site	Transport Company
<b>Transport equipment</b>	
<p><b>OPERATOR</b> Before the (un)loading operation starts, operators should check that the transport equipment offered meets all the requirements for the operation to be carried out.</p>	<p><b>DRIVER</b> Before entering the site, drivers should check that the vehicle and all ancillary equipment are fit for the operation to be carried out and meet all requirements as specified in the driver's instructions for the operation.</p>
<b>Site instructions</b>	
<p><b>OPERATOR</b> Operators should always adhere to the site instructions and be an example for drivers. Operators should witness the whole (un)loading activity.</p>	<p><b>DRIVER</b> Unless specifically agreed otherwise, drivers should always report at the gate or site entrance and ask for instructions. These instructions may include emergency procedures, required PPE, parking restrictions, route to loading or unloading point and general info such as the prohibition of smoking, alcohol and drugs, prohibition of the use of mobile phones, driving speed limits etc. Drivers should always adhere to the site instructions. Drivers should witness the whole (un)loading activity.</p>
<b>On-site driving and parking</b>	
<p><b>OPERATOR</b> Where possible operators should ensure that vehicles are driven and parked according to site instructions and should report any observed unsafe situations to the site management. The operator shall ensure that manoeuvring areas are kept clear to avoid congestion. When asked, the operator has to provide assistance for manoeuvring.</p>	<p><b>DRIVER</b> Drivers should proceed to the (un)loading area and park the vehicle according to site instructions. It is important to constantly assess the safety situation, not only whilst driving on site but also when arriving at the (un)loading point. For manoeuvring, the driver should ask for assistance if needed. Drivers should always take the necessary precautions to prevent any movement of the vehicle during (un)loading.</p>

Site	Transport Company
<b>Personal protective equipment (PPE)</b>	
<p><b>OPERATOR</b> Operators should wear PPE as required by site instructions and must ensure that the driver does the same.</p>	<p><b>DRIVER</b> Drivers should wear PPE as required by site instructions. As a minimum the driver should have the PPE listed in chapter <a href="#">‘Personal Protective Equipment (PPE)’</a>.</p>
<b>Emergency preparedness</b>	
<p><b>OPERATOR</b> Prior to the start of the operation, operators should indicate the location of the site safety equipment to the drivers, e.g.: fire extinguisher(s), eyewash &amp; safety shower, first aid equipment, emergency escape routes, emergency alarm activation, emergency stop, decontamination equipment and absorbent materials.</p>	<p><b>DRIVER</b> Prior to the start of the operation, drivers should check the location of the site safety equipment, e.g.: fire extinguisher(s), eyewash, safety shower, first aid equipment, emergency escape routes, emergency alarm activation, emergency stop, decontamination equipment and absorbent materials.</p>
<b>Documentation, Marking, Labelling and Sealing</b>	
<p><b>OPERATOR</b> The operator should check that all data on the transport documentation is in line with the goods to be (un)loaded and that the markings, labels and placards of the goods and the transport equipment is in accordance with the regulations. Operators should sign all relevant documents to confirm that the operation was satisfactorily completed. If there are any remarks, these should be written on these documents. If openings are (to be) sealed, the operator (un)seals the equipment and checks seal numbers mentioned on the transport documents.</p>	<p><b>DRIVER</b> The driver should hand over all relevant documents to the operator. Documents may include: weighing ticket, delivery note, certificate of analysis, cleaning document and transport document, if necessary with the required dangerous goods information. The driver should ensure that arrival/departure times, number of packages, temperature, pressure, volume and weights, as applicable, are noted and that signature(s) are obtained on all copies of the transport document. Customs and other documentation should be completed as per job instructions. Any deviations noted at the (un)loading point should be communicated by the driver to the site and be written on the transport documents before departure. The driver should ascertain that the correct markings and placards have been affixed to the vehicle. If openings are sealed, the driver checks the seal placement and seal numbers mentioned on the transport documents.</p>

Site	Transport Company
<b>Product samples</b>	
<p><b>OPERATOR</b> When required or agreed at order entry stage, the operator should ensure that the driver hands over the supplier's sample. Storing of samples in the drivers cabin should be avoided at any time. Product sampling directly from road tankers or tank containers should be avoided. If the taking of samples is absolutely unavoidable, they should be taken by qualified site personnel or appointed surveyors, with adequate safety precautions.</p>	<p><b>DRIVER</b> Drivers should ensure that the supplier's sample is stored in a safe way and handed over at the delivery point. Storing of samples in the driver's cabin should be avoided at any time. Packaging and labelling of the sample should be in accordance with legal requirements. Drivers should not take samples.</p>
<b>Working at Height</b>	
<p><b>OPERATOR</b> Operators should follow the site procedures when working at heights.</p>	<p><b>DRIVER</b> Drivers should follow the site instructions when working at heights.</p>
<p>See also <a href="#">ECTA/CEFIC best practice guidelines for the safe working at height in the chemical logistics supply chain</a></p>	
<b>Tank/Silo capacity and earthing</b>	
<p><b>OPERATOR</b> The operator should check if the tank/ silo can accommodate the quantity to be transferred. In the case of flammable products and bulk solids, ensure the equipment is earthed. Before loading, the operator should check the capacity of the transport tank/ silo or tank compartment with the driver. Before unloading the operator should check that the quantity and the product type can be transferred to the land tank or silo.</p>	<p><b>DRIVER</b> Before loading, the driver should check with the operator if the transport tank/ silo or tank compartment can accommodate the quantity to be transferred. In the case of flammable products and bulk solids, ensure the equipment is earthed.</p>
<b>Equipment under pressure</b>	
<p><b>OPERATOR</b> The operator should always make sure that the transport tank and/or equipment is not under pressure before making or breaking any connections and communicate with the driver. Upon the driver's request the operator shall provide a means to safely depressurize the vehicle.</p>	<p><b>DRIVER</b> The driver should always ensure that the transport tank and/or equipment is not under pressure before making or breaking any connections and communicate with the operator. Before leaving the site after (un)loading, the driver should seek permission from the operator to depressurize the tank, unless otherwise required.</p>
<p>No manipulations on couplings (also not tightening) should take place during (un)loading operations. For tightening leaking valves the operations should be stopped first.</p>	

Site	Transport Company
<b>Loading of liquids in multi compartment tanks</b>	
<p><b>OPERATOR</b> Operators should ensure that in filling the tanks, the regulations concerning the separation of dangerous goods in adjoining compartments are complied with. Operators should ensure that the correct product and quantity is loaded into the designated compartment(s) according to the load plan.</p>	<p><b>DRIVER</b> Driver should ensure that in filling the tanks, the regulations concerning the separation of dangerous goods in adjoining compartments are complied with. The driver should ensure that the operator is loading according to the driver's instructions.</p>
<b>Unloading equipment</b>	
<p><b>OPERATOR</b> The operator should check if the equipment owned by the site, e.g. product hose, vapour return or nitrogen/air pressure line, couplings, gaskets and seals, is in good condition, fit for purpose and product and pressure resistant. The operator should carry out a visual check on the internal cleanliness. For silo containers or Bag in Box containers that are unloaded by tipping, the operator should check that the 4 twist locks are fully engaged in the corner castings, the hand nuts are well tightened and fully locked with a locking system.</p>	<p><b>DRIVER</b> The driver should check if the equipment owned by the transport company, e.g. product hose, vapour return or nitrogen/air pressure line, couplings, gaskets and seal Including Rotary Valves (bag in box containers) are in good condition, fit for purpose and product and pressure resistant. The driver should carry out a visual check on the internal cleanliness. For silo containers or Bag In Box containers that are unloaded by tipping, the driver must check that the 4 twist locks are fully engaged in the corner castings, the hand nuts are well tightened and fully locked with a locking system.</p>
<b>Tank/Silo / connections</b>	
<p><b>OPERATOR</b> All site connections should be properly marked/ labelled. The operator is responsible for correctly connecting/fitting product hoses and vapour return or nitrogen/air pressure lines to the storage tank/ silo, whilst the driver is responsible for making the connections to the vehicle, unless site procedures stipulate otherwise (such as unaccompanied transports). When making or breaking connections, coordination and cooperation between the operator and driver is of vital importance to avoid incidents.</p>	<p><b>DRIVER</b> The driver should be familiar with the equipment of the vehicle, e.g. (un)loading valves, pressure/vapour return connections, number and capacity of compartments, hoses, couplings and gauges. The driver is responsible for making the connections to the vehicle, whilst the operator is responsible for making the connections to the storage tank/ silo, unless site procedures stipulate otherwise. When making or breaking connections, coordination and cooperation between the driver and operator is of vital importance to avoid incidents.</p>

Site	Transport Company
<b>Permission to (un)load</b>	
<p><b>OPERATOR</b> The operator should give explicit approval to the driver to operate equipment on the vehicle such as valves, compressor and pump. Operators should operate the storage tank valves, pressure valves and the pump, as applicable.</p>	<p><b>DRIVER</b> The driver is only allowed to operate equipment on the vehicle such as valves, compressor and pump after explicit approval of the operator. The driver should not operate site equipment. For driver controlled (un)loading explicit agreement between the carrier and the site, including training requirement, is necessary to allow drivers to operate site equipment.</p>
<b>Vehicle restrictions</b>	
<p><b>OPERATOR</b> The operator, in co-operation with the driver, should ensure that the maximum permissible vehicle gross weight is not exceeded and that the minimum and maximum permissible degree of filling of the tanks is observed. It is recommended to issue a load distribution plan which is signed by the driver.</p>	<p><b>DRIVER</b> The driver, in co-operation with the operator, should ensure that the maximum permissible vehicle gross weight is not exceeded. During loading of the vehicle, the driver should take all possible precautions not to exceed the maximum permissible axle weights.</p>
<b>Disconnection</b>	
<p><b>OPERATOR</b> Operators should ensure that before disconnecting hoses, all valves are closed and all hoses are free of pressure and product. The site shall enable a safe way for the driver to verify the load has been discharged entirely.</p>	<p><b>DRIVER</b> Before departure the driver should ensure that the entire load has been discharged, that all hoses are disconnected, drained, blanked off (if necessary) and properly stored. All manlids and valves should be closed and properly tightened. The earthing cable as well as any loose equipment should be cleared away. The driver should ensure that it is safe to leave the (un)loading point by undertaking a visual inspection whilst walking around the vehicle.</p>
<b>Reporting of unsafe situations, near misses and incidents</b>	
<p><b>OPERATOR</b> Operators should report all (un)loading problems, unsafe situations or conditions, near misses and incidents, as per company procedure.</p>	<p><b>DRIVER</b> Drivers should report all (un)loading problems, unsafe situations or conditions, near misses and incidents, as per company procedure.</p>



Site	Transport Company
<b>Stowage, Securing and Segregation of packed goods</b>	

**OPERATOR**

Before starting loading, operators should ensure that packages that are already loaded on the vehicle when it arrives at the loading site are stowed and secured in an adequate way so that they cannot damage the goods to be loaded. Operators should ensure that packages are stowed and secured in such a way that they cannot move in any direction. Free space between packages should be avoided and sufficient lashings should be applied, according to site instructions. Special precautions should be taken when packages of different types are stowed on the same vehicle. Operators should ensure that the regulations on prohibition of mixed loading and the regulations concerning separation of food stuffs, animal feedstuffs etc., are followed, taking into account the goods that are already loaded in the vehicle. Operators should not allow the vehicle to leave the (un)loading site in an unsafe condition.

**DRIVER**

The driver should prepare the vehicle for (un)loading (i.e. opening doors and canvas, removing blocking and bracing material, undoing the strapping etc.) Whilst ensuring that sufficient packed goods cargo securing equipment is available for loading purposes in line with site instructions. When opening the doors of the vehicle, the driver should always be aware of the possibility of packages falling out. Before loading commences, the driver should ensure that packages that are already loaded on the vehicle when it arrives at the loading site, are stowed, if necessary segregated, and secured in an adequate way so that they cannot damage the goods to be loaded. Drivers should ensure that packages are stowed and secured in such a way that they cannot move in any direction. Free space between packages should be avoided and sufficient lashings must be applied. Drivers should not leave the (un)loading site without checking stowage and securing.

More detailed guidance concerning the roles and tasks for load securing are included in [Annex 4: Roles and Tasks for load securing in Cargo Transport Units](#)

### 3. SQAS and ESAD

Part of the responsibilities of the organisation is to risk assess its supply chain as described throughout this document.

When the supply chain comprises contracted road transportation, rail transportation, warehousing and tank-cleaning the on-site risk assessment described in this guideline is to be complemented by a system to qualify and periodically review carriers, distributors and third-party providers based on Responsible Care or other health, safety, security and environmental performance criteria.



One efficient way to accomplish this is through SQAS and ESAD.

The SQAS and ESAD schemes consist of a team of accredited assessors that visit and assess each Logistics Service Provider or distributor according to a standardised and uniform questionnaire.

Those questionnaires are freely available in multiple languages on

[www.sqas.org](http://www.sqas.org).

The organisation will go through the questionnaire once to select the questions relevant to his business and can – provided he subscribed to the user group – download reports of assessed logistic suppliers and distributors and apply the selection (called a ‘template’) to the reports, thus avoid having to spend time with each LSP or distributor covering what are actually standard industry requirements. Likewise it saves the LSP or distributor time covering the same standard industry audits with each customer.

The saved time can thus be spent discussing what gaps are identified through this process and what, if any specific business requirements are not covered in SQAS.

The effort serves the LSP or distributor as a risk assessment tool for his own operations and provides him with a reference of industry standards, benchmark and internal auditing all in one assessment.

## 4. Emergency response plan

The on-site emergency plan, must address procedures for dealing with emergency situations involving loss of containment, fire, explosion etc.

It should include:

- Containing and controlling incidents so as to minimize the effects and to limit danger to persons, the environment and property;
- Implementing the measures necessary to protect persons and the environment;
- Description of the actions which should be taken to control the conditions at events and to limit their consequences, including a description of the safety equipment and resources available;
- Arrangements for training staff in the duties they will be expected to perform;
- Arrangements for informing on-site personnel local authorities and emergency services, drivers and visitors

The emergency plan should be simple and straightforward, flexible and achieve necessary compliance with legislative requirements. Furthermore separate on-site and off-site emergency plans should be prepared.

### 4.1. Emergency operating procedures / training

---

The emergency procedures should include instructions for dealing with fires, leaks and spills. The procedure should describe how to:

- Raise the alarm and call the fire brigade;
- Tackle a fire or control spills and leaks (when it is safe to do so);
- Evacuate the site, and if necessary nearby premises.

### 4.2. Area evacuation

---

Evacuation of areas in the event of fire or toxic gas emission should be addressed in an emergency evacuation procedure. This should specify designated safe areas, assembly points and toxic gas shelters. The procedure should also identify responsible personnel whose duties during area evacuation include:

- Responsibility for a specific area;
- Collecting ID badges
- Communication of missing persons to central emergency services.

### 4.3. Fire fighting

---

A fire fighting strategy should consider:

- Appointment of fire fighters, with subsequent training;
- Location plans of fire hoses, extinguishers and water sources;
- Access for emergency services;
- Provision of firewater

#### 4.4. Removal of substance to a safe place

---

The emergency spill control procedure should include the following key sections:

- Spills involving hazardous materials should first be contained to prevent spread of the material to other areas. This may involve the use of temporary diking, sand bags, dry sand, earth or proprietary booms / absorbent pads;
- Wherever possible the material should be rendered safe by treating with appropriate chemicals
- Treated material should be absorbed onto inert carrier material to allow the material to be cleared up and removed to a safe place for disposal or further treatment in accordance with legislation

#### 4.5. Stabilisation / dilution to safe condition

---

Once the hazardous material has been contained to prevent spread of the material to other areas, the material should be treated wherever possible to render it safe. Acids and alkalis may be treated with appropriate neutralising agents. Due to the differing properties of the various groups of chemical, an appropriate treatment strategy with suitable chemicals should be established in each case. For example, highly concentrated hydrochloric acid will fume when spilled so prior to neutralization the spill should be diluted with a water spray.

Once the material has been treated the area should be washed with large volumes of water. Most chemical plants and associated areas are serviced by chemical drains that feed to the effluent treatment plant. The washing operation will represent an abnormal loading on the effluent treatment plant, and it is vital that in any situation where this is likely to happen the staff responsible for operation of the effluent treatment plant are notified so that appropriate measures can be adopted.

#### 4.6. Availability of neutralizing substances / foam

---

Process specific emergency spill kits (acid, alkali, solvent, toxic etc.) and appropriate personal protective equipment should be readily available with supporting procedures. These spill kits should be maintained on a regular basis to ensure that they are always available and fit for purpose. This ensures that the most appropriate measure is on hand to deal with a spill or fire in the most effective way.

## 5. Applicable legislation

This guideline gives a generic overview of applicable legislation.

Different companies are involved in (un)loading of chemicals, this could be

- chemical plant
- terminal
- warehouse
- transport company.

All have to deal with applicable legislation.

The legislation can be divided into different parts:

- Health and safety
- Process safety
- Environment
- Transport

These are important for all parties. The degree of importance or impact is dependent on the role of the different parties within the supply chain. The schematic below gives an overview.

If a company deals with hazardous materials, like ADR classified or carcinogenic materials, rules on process safety and environment can be more severe than companies who do not handle dangerous materials.

Producers are most likely the parties who have the most Health and Safety information about their products.

The (un)loading site should have detailed information about the environmental and process safety requirements of their site.

The transport company should have in depth knowledge about transport regulations.



All employers in the logistics supply chain are responsible and accountable for their employees to ensure a safe and healthy working environment.

In order to do so it is important that sites/employers give relevant information concerning safety at the work place, to employees of outside undertakings, such as transport companies.

For example an LSP working at an (un)loading site must ensure their driver can undertake the work in a safe manner, based on information supplied by the chemical company.

A more detailed overview of legislation can be found in '[Annex 5: Hierarchy and lists of applicable legislation](#)' for an overview of the applicable legislation at the time of the publication of this guideline.

## 6. Communication skills of drivers and operators

Communication at (un)loading sites is one of the most common sources for discussion and unsafe actions during (un)loading. Therefore, ensuring that communication between drivers and operators can be made in an understandable way for both parties is key for success. This involves making sure that the (un)loading sites make their general instructions clearly understandable, preferably by making use of pictures instead of words.

For assuring that drivers and operators understand each other when communicating during the (un)loading process a common language has to be found.

For international transport, drivers and operators often do not share a common language; both drivers and operators should be familiar with a fixed set of the most common expressions in a shared language.

Based on practicability, a short set of 142 expressions in English is the platform of choice for this.

Both transport companies and (un)loading locations should make sure that their drivers/operators have knowledge and can make use of at least the fixed set of expressions in English.

The expressions required to be known by both drivers and operators are the ones defined in Transperanto ([www.transperanto.org](http://www.transperanto.org)). The number of expressions required is dependent on the specific work area the drivers and operators are active in (e.g. packed, bulk liquid, ADR, ...) and is a subset of currently 142 expressions. See also [Annex 8: \(Un\)loading expressions / list in English](#) Many of these expressions are also conveyed by pictograms see: [www.transperanto.org](http://www.transperanto.org)

Transport companies and (un)loading sites should ensure that their drivers and operators obtain the required skills. This can also involve the development of supporting means (e.g. leaflets, apps, handbooks).

Rather than instructing by elaborate sentences, pictures or pictograms can be used. Some examples can be found in [Annex 9: Examples of pictographic loading](#) instructions

Directive 2003/59/EC obliges professional drivers to undergo periodic retraining in the skills essential for their profession.

This obligation is intended to improve road safety and the safety of the driver, including during operations carried out by the driver while the vehicle is stopped. Furthermore, the modern nature of the profession of driver should arouse young people's interest in the profession, contributing to the recruitment of new drivers at a time of shortage.

One of the objectives that this Directive is trying to reach is the ability to adopt behaviour to help enhance the image of the company (Objective 3.6)

## Part B: Technical aspects

The following chapters of the 'Best Practice Guideline' list a number of standardisations and technical requirements that will improve the safety and sustainability of the chemical supply chain by reducing the interface mismatches.

These include standardisation of [driver PPE](#) (Personal Protective Equipment), [couplings and hoses](#), communication and information tools such as [SULID](#).

### 7. Technical requirements (un)loading sites

'[Annex 7: Examples of Risks and Risk mitigation for \(un\)loading operations](#)' gives a brief overview of possible technical measures that can be taken to mitigate the risks that can occur at an (un)loading place. Examples of risks can be:

- overflow
- over pressure
- under pressure
- exposure to product
- exposure to vapours
- fire/explosion
- chemical reactions
- unwanted movement of vehicles
- fall from vehicle
- high temperatures of product

Example of specific risk and requirements for safety on bulk solid unloading sites can be found in [Annex 1: Example Risk assessment for Bulk Solids Unloading sites](#)

It is the responsibility of the (un)loading sites to assess the risks of (un)loading operation and to determine the measures to be taken. They are dependent on the potential effect of the failure as well as the probability.

The risk can be product related, e.g. the effects of an overflow of a tank will be much more severe for a tank containing toxic material than for one containing water. Also the quantity of the product involved can play a role in the potential effect.

Examples of risk tables of products, split into different groups, to illustrate the potential different risks and measures can be found in '[Annex 7: Examples of Risks and Risk mitigation for \(un\)loading operations](#)' along with some non-standard operations which – unless specifically agreed between the parties – should be eliminated from the supply chain.

Access and egress of trucks to and from the site needs to be considered

- Separation of truck traffic and pedestrians
- Truck manoeuvring, including the need to back up a vehicle

See [Annex 2: Pictorial examples of Access/ Egress to the \(un\)loading area](#) for some pictorial examples.

- Accessibility of the site through public roads; consider roundabouts, bridges and crossings. Routing instructions can be communicated through [SULID: Site \(Un\)Loading Information Document](#)

## 8. SULID: Site (Un)Loading Information Document

### 8.1. Legislation

---

The European Council states in article 10 from Directive **89/391/EC**:

Every employer shall take appropriate measures so that employers of workers from any outside undertakings and/or establishments engaged in work in his undertaking and/or establishment receive, in accordance with national laws and/or practices, adequate information concerning:

- a) the safety and health risks and protective and preventive measures and activities in respect of both the undertaking and/or establishment in general and each type of workstation and/or job;
- (b) the measures taken for the points referred to in paragraph a.

Each member country has integrated this directive in National Legislation.

To comply with this legislation every (un)loading site has to inform the management of each haulier that could be present on their site.

The implementation of the above differs from country to country and from (un)loading point to (un)loading point.

In France it is usual that a 'Protocol de sécurité' is sent to the suppliers which then distribute this information further to the potential hauliers to be evaluated and signed (every year). This protocol differs from a single information leaflet to a ten page risk assessment document. This way of working takes a lot of time and effort with limited added value.

In other countries / companies the situation is variable and differs from no information at all, to entrance gate info for the driver to a full package addressed to the management of the haulier.

Most of the information that is offered has been drawn up by the management of the (un)loading company without any independent or suppliers verification.

Some suppliers perform an audit for (primarily) High Consequence Dangerous Goods (HCDG) prior to the first delivery but this information is rarely shared with the hauliers.

### 8.2. SULID-template

---

The 'Site (Un)Loading Information Document' has been created in 2011 in cooperation between CEFIC, ECTA and FECC to produce an industry standard document. At the time of this publication the document is available in four languages.

This documents lists all practical (technical and safety related) information about the (un)loading point in combination with the protective and preventive measures, submitted by the (un)loading site. SULID doesn't include a risk assessment but is an excellent starting point to identify the (potential) risks and gives a clear picture of the existing situation.

A SULID is available for three different types of (un)loading sites depending on the nature of the products to be handled:

- Bulk liquids
- Bulk solids
- Packed goods

SULID is mainly an information document and doesn't provide an evaluation nor a classification of the different (un)loading sites.



### 8.3. How to use the SULID

---

A blank document is available on the Cefic, FECC and ECTA websites as a writable PDF document supplemented with further guidance.

Every company/shipper who wants to make use of the document should download it and send it to the operating sites where the products are being loaded and unloaded. This can be:

- their own site(s)
- sites operated by other companies

### 8.4. SULID-website

---

A website that includes all information about each (un)loading point should be considered by all stakeholders.

Advantages are:

- centralized and always up to date information (including SULID) about each (un)loading point
- easy access to approved stakeholders including approved hauliers
- direct proof of information delivery (to comply with the Directive)
- no time consuming mailing for each information document

## 9. Information, instructions and training for drivers and operators

Drivers coming to (un)load on a site have to be properly informed of the site safety requirements, route to take, (un)loading method, product hazards etc.

See '[SULID: Site \(Un\)Loading Information Document](#)' for the best practice format.

Listed below are contents for information, instructions and training for drivers and operators at (un)loading sites. The (un)loading sites should use those elements which are relevant for their operators. Relevancy depends on factors like the presence of hazards or the degree of coaching, guidance and assistance of site personnel.

### 9.1. General information and instructions for drivers and operators

---

Following items are common information and instructions for both driver and operators and are to be incorporated in both the driver's and the operator's training programs.

#### 9.1.1. Loading/ unloading instructions

---

- Loading/ unloading method [Unloading scenario's bulk liquid](#)
- Maximum pressure
- Use of vapour return
- Forklift segregation rules
- Load securing requirements

#### 9.1.2. Emergencies and Alarms

---

- What kind of alarms (warnings/standby, fire alarms, gas alarms, tests)
- Who can raise/activate an alarm
- When to raise/activate an alarm
- How to raise/activate an alarm (phone numbers, buttons)
- What actions to take in case of alarm
  - Site plan with destination location, evacuation routes, assembly points
  - Different action pending on the kind of alarm
  - When (un)loading
  - What about truck and keys
  - Other attention items
  - After the signal of situation safe has been given

#### 9.1.3. Health and environment

---

- Be informed about the health and environmental hazards of the products in/on the truck.
- Know the ADR hazard signage and pictograms.
- Use the appropriate PPE.
- Act accordingly in case of exposure to product.
- Deal with waste or spills.
- Highlight and report issues, unusual events, incidents promptly.

#### 9.1.4. Reporting of injuries, incidents, -unusual events and environmental complaints

---

Instructions about reporting

What: injuries, environmental incidents, near misses, safety observations

When: promptly, timely

How: verbal, written, phone

To whom: site personnel, drivers own organization

### 9.1.5. Communication formats

---

Listed below are formats to communicate and train (un)loading site information and instruction to drivers. Adequate signage and safety instructions at the entry to the site and the (un)loading area are considered as a minimum requirement. The (un)loading site should consider adding a combination of formats mentioned below.

- Display signs, placards, posters
  - Traffic rules and road marks
  - Prohibition and obligation signs at the entrance for general site rules and specific signs at the (un)loading area
  - Incident/accident equipment locations and instructions (important at the (un)loading area)
    - First aid kit
    - First aid intervention contacts
    - Stop button
    - Fire fighting equipment
    - Spill absorbent
  - Emergency instructions as signs/pictograms (important at the (un)loading area)
    - Alarm button
    - Emergency number
    - Escape routing
    - Emergency shower / Eye wash station.
  - Coaching/monitoring at the (un)loading area as per operator/driver roles and responsibilities
- PowerPoint or video, covering selected content based on photographs/video of recognizable site situations, with spoken or written comment.
- Flyer/leaflet, covering all content based on photographs of recognizable site situations depending on the site hazard severities, strengthened with written comment
- Test on comprehension, not on prose-language skills.
- (un)Loading permit, with main matters highlighted about emergencies/alarms, site circulation,
- (un)Loading instructions
- Site Safety Certificate or Safety Passport, for an experienced, regular/frequent and trained/informed driver – entry permit without extensive training

See [Annex 9: Examples of pictographic loading instructions](#) for practical examples.

## 9.2. Driver specific information and instructions

---

### 9.2.1. Drivers access rules

---

- Language requirements; [Communication skills of drivers and operators](#)
- Identification and required documents
  - ID or passport
  - Driver's license
  - Drivers training certificates
  - Truck certificates (technical, cleaning document)
  - Product related (transport) documents
- Special rules: frequent visitor, accompanied by others
- Facilities (toilet, shower, catering)

### 9.2.2. Site circulation instructions, traffic rules, truck (un)loading preparation

---

- Site plan with the location of the destination

- Use of access pass/badge: Should it be visible at all times or only for entry and exit.
- Speed limits
- Wearing of seat belt
- Parking rules; Never block roads, escape routes, rail tracks, entrances or exits
- No mobile phone use while driving (not even hands free !)
- Specific arrangements and instructions for mixed traffic areas (pedestrians, forklifts.)
- Documents available (any goods taken on site need to be accompanied with the proper documents)
- Truck preparation
  - Engine off
  - Wheel chocks
  - Electricity off
  - Earthing
  - Support legs
  - Keys

### 9.2.3. PPE

- General site PPE requirements, which need to be communicated to the transport companies in time [Personal Protective Equipment \(PPE\)](#) and [SULID: Site \(Un\)Loading Information Document](#)
- Special PPE requirements for specific un/loading installation, which should be agreed upon in the contract with the transport companies
- Instructions (by instruction or signs)
  - Special PPE available/provided at/by the (un)loading site
  - Use of PPE in a proper way
  - Replace defective PPE, only use PPE that is in good condition



Example of a PPE pictogram

### 9.2.4. Do's

- Follow the instruction of the site personnel and (un)loading operator
- Obey the instructions on the traffic signs, the direction signs and the prohibition signs
- Make sure that you know the emergency arrangements:
  - Emergency/Alarm signals
  - Where to find alarm buttons
  - Emergency numbers
  - Where to find first aid and medical assistance
  - Where to find emergency showers, eye showers
  - Where to find fire extinguishers
  - Where to find evacuation routes and assembly locations

### 9.2.5. Don'ts

---

- No alcohol and/or drugs
- No use of camera's
- No ignition sources:
  - No fire/lighters/matches
  - No smoking
  - No mobile phone use
- No climbing on trucks (working at heights) without fall protection
- No plant equipment use without permission
- No entry of blocked premises or roads
- No eating and drinking (can be different per (un)loading site)

### 9.2.6. Product specific training

---

For products with severe hazards (flammables, health hazards) loaders/shippers may choose to develop/provide training and information about:

- Product characteristics
- Specific PPE
- Handling requirements
  - Loading key safety requirements
  - Delivery/unloading key safety requirements
- What to do in case of an undesirable event (accidental contact, accidental release, runaway reaction, fire)
- Reporting of near misses and/or undesirable events

Suggested formats

- Classroom 'train the trainer' or training
- Leaflet, checklist with coaching on how to use equipment

## 9.3. Operator specific information and instructions

---

All operators working at production plants and other (un)loading sites should have been trained according to the legal standards required for their type of work.

Besides the legal requirements the company should provide operators with Plant/(un)loading Operating Procedures that are trained and explained by an experienced operator.

In an activity based program all operators should gain theoretical knowledge of the plants and (un)loading facilities.

When finalizing the theoretical knowledge training they should be tested by an experienced technician/operator.

These tests are planned for the operator via a training scheme with repetition of key elements to reinforce the learning.

Operators working at (un)loading installations necessarily work with outside partners in an area where behaviour is of paramount importance. Each of the chapters in [Part A: Organizational and Behavioural aspects](#) should be integral part of the training program.

## 10. Personal Protective Equipment (PPE)

This chapter focuses on Personal Protective Equipment (PPE) as the last barrier of defence to protect the driver against risks during (un)loading activities in a chemical plant environment. The required PPE for site access are complementary to the requirements of ADR for PPE for the risks during driving and in case of accidents or emergencies during transport.

This chapter covers only general PPE requirements that are applicable for general chemical products of 'most' sites. For specific products (e.g. class 8 or 6.1) and/or for specific chemical plant environments, additional specific PPE may be required in accordance with the relevant SDS and risk assessments. These additional PPE requirements are not included in the present document and are to be communicated to the carrier with sufficient notice ref: '[SULID: Site \(Un\)Loading Information Document](#)' or will be made available by the chemical plant.

### 10.1. Risk Analysis

---

Personal Protective Equipment (PPE) requirements for site access of contractors, including drivers, are defined based on a risk analysis of the task to be performed and the environment in which the task is performed. See '[Management responsibilities](#)' for guidance on risk assessment. As products, tasks and environments differ from plant to plant the PPE requirements for contractors will be equally different.

Drivers make a unique exception to this differentiation as drivers usually visit and work on several locations.

When sites prescribe PPE at a lower level of protection as detailed in this chapter, it is recommendable that site management performs a task specific risk review to confirm the adequateness of the level of protection of the PPE.

When sites prescribe PPE at a higher level of protection than the PPE guidance provided in this chapter, it is recommendable that the management of the transport company together with the site management perform a joint task specific risk review to confirm this requirement for such higher level of protection.

Wearing PPE may introduce additional risks. The risk analysis should include such considerations.

- Safety glasses may limit or hinder sight.
- Ear protection hinders verbal communication.
- Safety gloves will limit the capabilities of the hands: fine motor control, tactile sense...
- Safety shoe with rigid or steel sole decrease the sensitivity of the driver to the pedal. As safety shoes are usually mandatory on-site even inside the cab these are not recommended.

High laced shoes (for ankle-protecting) have an additional protection but can be uncomfortable for driving.

## 10.2. 3 different sets of PPE

---

Across all Chemical sites drivers conduct 3 different combinations of tasks and environments. Therefore 3 different sets of PPE are required dependent on the type of chemical products that are being transported and handled.

### 10.2.1. Type 1: packed goods and drop-and-swap

---

Drivers (un)loading sealed **packed goods** and drivers carrying out **drop and swap** operations (i.e. dropping off or taking on a trailer/container at/from a chemical or storage facility without performing product (un)loading activities).

These drivers access chemical sites but are not likely to be exposed to chemicals. Equally they are not likely to have to engage in working at height nor do their tasks usually involve risk of flammable atmospheres.

### 10.2.2. Type 2: bulk granulates

---

Drivers (un)loading **bulk granulates** or solid chemicals without danger classification access chemical sites but are not likely to be exposed to chemicals as such. But they often engage in working at height. Their tasks and environment do not usually involve risk of flammable atmospheres.

### 10.2.3. Type 3: bulk liquids and DG solids

---

Drivers (un)loading **bulk liquids** (ADR and non-ADR) and classified solids (ADR) access chemical sites and work in areas where the likelihood of being exposed to chemicals they carry or chemicals already present in vessels or lines can't be ignored. Equally they often have to engage in working at height and their tasks might involve risk of flammable atmospheres if those are present at or near to the (un)loading location (not limited to those arising from the product they transport).

## 10.3. Sets of required PPE for different types of (un)loading operations

---

The selection of the sets of PPE is based on the risks of these types of products and the risks related to the activities in a chemical plant environment, which are not necessarily limited to the loaded/unloaded product.

These sets of equipment need to be available to the driver at all times.

Most of the equipment has to be worn while working on any chemical site.

Specific items such as the fall arrest harness and hearing protection are used in specific circumstances. The chemical site will agree with the driver upon these circumstances.

Listed below are PPE by type as described above in relation to the applicable standards and some additional clarification. Where multiple norms apply, the item needs to comply with each norm listed.

The required PPE needs to be used properly, kept in good condition and the drivers are to be adequately trained to use them.

PPE	Reference to standard	Type of operation		Description
Safety Spectacles	EN 166-3 with side protection	Type 1 : Drivers loading / unloading packaged goods + drop and swap operations.	Type 2 : Drivers loading and unloading bulk granulates or other solid chemicals without danger classification	Protection against liquid droplets/splashes Minimum EN 166 with side protection. This side protection is guaranteed if special shaped spectacles are used. If straight shape spectacles are used, side protectors are to be present.
Protective clothing	Arms + legs + body covered			For packaged goods, drop and swap and bulk granulates protective clothing which covers arms + legs + body is sufficient. Both a jumpsuit or vest + trousers are OK.
Safety shoes	EN 20345 S1 – closed			Steel toe, antistatic, absorption around heel. Safety boots are acceptable too. Rigid or steel soles are not recommended as it is uncomfortable for driving. Clogs, even EN 20345 are not accepted. <sup>(1)</sup>
Helmet	EN 397			Industrial helmet protection. Safety caps do not provide sufficient protection from falling objects.
Safety gloves (mech. risks)	EN 388		Type 3 : Drivers loading and unloading bulk liquids (ADR and non-ADR) and solids (ADR)	Safety gloves with protection against mechanical risks.
Warning vest	EN 471			High-visibility clothing for professionals – warning vest Same standard of high visibility clothing is already required for ADR as well as for all drivers in most European countries.
Fall arrest harness	EN 361			See Note on Transportation Equipment Elevated Work
Safety goggles	EN 166			For bulk liquids and solids (ADR) use of goggles is required which can also replace a normal safety spectacle. These are also preferable when (non-dangerous) dust can occur during operations. Goggles are to be strapped to the head, not to the helmet.
Safety gloves (chem. risks)	EN 374 JKL or according to product			Safety gloves with protection against chemical risks JKL : test chemicals are n-heptane, NaOH 40 % and H <sub>2</sub> SO <sub>4</sub> 96 %
Protective clothing	EN 533 EN 1149/5 EN 13034 type 6			<ul style="list-style-type: none"> <li>○ Protective clothing with limited flame spread properties.</li> <li>○ Protection against the danger caused by static electricity.</li> <li>○ Limited protection against liquid chemicals, type P(6)</li> </ul>
Safety shoes	EN 20345 S2 – closed			As S1 + water resistance of upper. In some circumstances safety boots may be required. Rigid or steel soles are not recommended as it is uncomfortable for driving. Clogs, even EN 20345 are not accepted. <sup>(1)</sup>

<sup>(1)</sup>Note on safety shoes.

1. Safety shoe with rigid or steel sole decrease the sensitivity of the driver to the pedal. As safety shoes are usually mandatory on-site even inside the cab these are not recommended.
2. High laced shoes (for ankle-protecting) have an additional protection but can be uncomfortable for driving.



## 11. Unloading scenario's bulk liquid

In no order of preference the 4 most common scenarios for unloading bulk liquids are:

1. Bottom unloading by pump and vapour return
2. Bottom discharge by pump without vapour return
3. Bottom unloading by compressed air or inert gas.
4. Top Discharge

For each of these scenario's the text below will describe key characteristics, main advantages and disadvantages and conditions for safe practice.

The document focuses on (un)loading operations both through the top or via the bottom of vehicles, this is commonly done with a flexible hose but an (un)loading arm can be considered too.

### 11.1. Bottom unloading by pump and vapour return

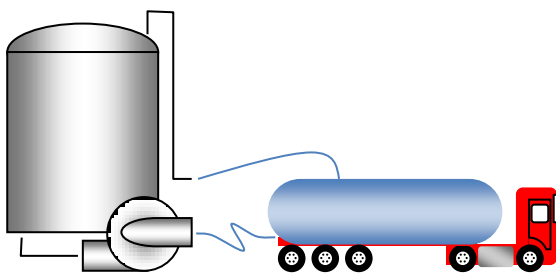

The pump will be filled with liquid by gravity and will provide the necessary energy to the product to overcome the gravitational backpressure and flow restrictions. The pump will be connected to the vehicle by a flexible hose of sufficient diameter (usually 80mm -3"). The liquid flowing will simultaneously create more vapour-space in the vehicle and less in the site tank. A flexible hose (minimum 25mm -1") connecting both vapour-spaces will balance the pressure and prevent

vacuum in the vehicle.

#### 11.1.1. Main advantage

In case of emergency the power to the pump is cut which immediately cuts the flow of product. This is a significant safety advantage over pressurized discharge.

Vapour in the site tank will flow to the truck and not be lost to the atmosphere.

#### 11.1.2. Main disadvantage

For connecting the vapour return access to the top of the vehicle is often required. An exception to the rule is a ground-operated truck.

#### 11.1.3. Condition of use

Any obstruction in the vapour return line (a closed valve, a lump of frozen or polymerized material, etc.) will create an overpressure in the site tank and a vacuum in the vehicle. Positive proof of flow in the vapour return line is required.

The pump should be site-owned. A mobile pump on the truck might be a cheaper solution in the short term but adding a pump to the carrier's equipment increases the tare weight which in turn reduces the net weight carried. A truck-owned pump increases the cost and CO<sub>2</sub> burden of the supply chain unnecessarily.



## 11.2. Bottom discharge by pump without vapour return

---

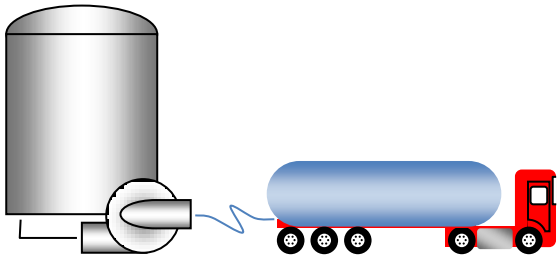

The pump will be filled with liquid by gravity and will provide the necessary energy to the product to overcome the gravitational backpressure and flow restrictions. The pump will be connected to the vehicle by a flexible hose of sufficient diameter (usually 80mm -3"). The liquid flowing will simultaneously create more vapour-space in the vehicle and less in the site tank. The Site tank's vapour will exit the tank to the atmosphere (possibly through a scrubber or Vapour-recovery-unit). The vehicle's tank needs to be opened at the top to allow air to enter the tank.

### 11.2.1. Main advantage

---

In case of emergency the power to the pump is cut which immediately cuts the flow of product. This is a significant safety advantage over pressurized discharge.

### 11.2.2. Main disadvantage

---

For opening the vapour valve, access to the top of the vehicle is often required. Working at height needs to be considered by the site.  
An exception to the rule is a ground-operated truck.

The site tank's vapours will need to be taken in consideration. Vacuum collapse of the vehicle's tank has to be considered. Vehicles are not process equipment. Because of their purpose they cannot be considered to have effective vacuum protection of sufficient size to accommodate discharge. Often vehicles do have sufficient protection to compensate vacuum created by absorption or cooling, but these are processes that are significantly less demanding on the equipment.



### 11.2.3. Condition of use

---

Vapour exiting the site tank needs to be considered. Depending on the nature of the product a scrubber or vapour recovery unit might be required to eliminate emissions of chemicals to the environment.

The pump should be site-owned. A mobile pump on the truck might be a cheaper solution in the short term but adding a pump to the carrier's equipment increases the tare weight which in turn reduces the net weight carried. A truck-owned pump increases the cost and CO<sub>2</sub> burden of the supply chain unnecessarily.

The pump should be of self-suction design and not require the tank to be put under pressure. Putting the tank under pressure to flood the pump means the tank has to be opened quickly as soon as the pump starts to avoid vacuum damage.

For 'Flexitanks' (bag-in-box-containers) the risk of vacuum collapse is evidently non-existent.

### 11.3. Bottom unloading by compressed air or inert gas.

---

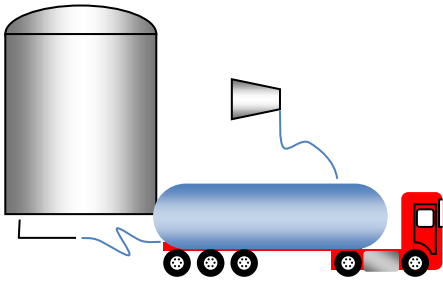

The liquid will flow to the tank powered by the pressure of the air or gas flowing from the compressor.

The site tank will be connected to the vehicle by flexible hose of sufficient diameter (usually 80mm -3"). The site tank's vapour will exit the tank to the atmosphere (possibly through a scrubber or Vapour-recovery-unit if installed). After discharge the vehicles' tank needs to be brought to atmospheric pressure before the vehicle can be allowed to exit the site.

#### 11.3.1. Main advantage

---

Since there is no pump, you do not have to worry about the cleanliness of the pump. The compressor does not come in contact with the product so there is less risk of contamination.

#### 11.3.2. Main disadvantage

---

After discharge the vehicle's tank is under pressure.

For connecting the compressor to the vapour valve, access to the top of the vehicle is often required. An exception to the rule is a ground-operated truck.

The Site tank's vapours will need to be taken in consideration.

#### 11.3.3. Condition of use

---

Of course you cannot blow pressurized air into a flammable atmosphere. Use of inert gas is then required. When using inert gas the safety of the tank cleaning personnel needs to be considered. Attach a nitrogen-warning label to the manlid.

Make sure the tank can resist the maximum pressure from the compressor so to avoid over-pressurizing the vehicle's tank. At the end of the discharge the pressure in the vehicles tank will blow the lines to the site tank and pressure will be transferred to the site tank.

It is not acceptable to return a pressurized truck on the road after discharge. Neither tank cleaning stations nor carriers have the equipment to reduce this pressure before opening the tank for cleaning. Simply opening a vapour valve en-route is environmentally unacceptable. The pressure in the vehicle's tank has to be reduced to atmospheric at the discharge site.

Vapour exiting the site tank needs to be considered. Depending on the nature of the product a scrubber or vapour recovery unit might be required to eliminate emissions of chemicals to the environment.

The compressor should be site-owned. A mobile compressor on the truck might be a cheaper solution in the short term but adding a compressor to the carrier's equipment increases the tare weight which in turn reduces the net weight. A truck-owned compressor increases the cost and CO<sub>2</sub> burden of the supply chain unnecessarily.

An exception to this rule are tilting-trailers. Those can use the compressor that drives the hydraulics of the tilting mechanism.

## 11.4. Top Discharge

---

Some vehicles are designed with 'dip-pipes' to accommodate top-discharge.

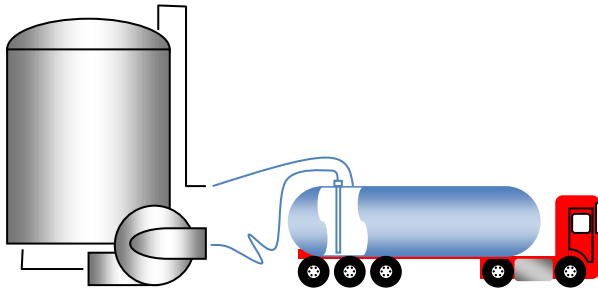

The same possibilities exist as for bottom discharge except that – since access to the top of the vehicle is already required for connecting the liquid-hose. Having to access the top of the vehicle for connecting or opening the vapour connection is no longer a disadvantage. (Provided of course the site has taken the relevant working at height precautions)

### 11.4.1. Main advantage

---

Since there are no openings under the liquid-level, the risk of tampering is significantly reduced.

### 11.4.2. Main disadvantage

---

Access to the top of the vehicle is required.

### 11.4.3. Condition of use

---

Working at height needs to be considered by the site and the carrier.

Clear indications of which connection is 'liquid' and which is 'vapour' is critical. It is not possible to unload product wrongly connected but loading the truck with connections reversed will immediately flood the vapour-return lines.

## 12. Couplings and hoses for bulk liquids and gasses

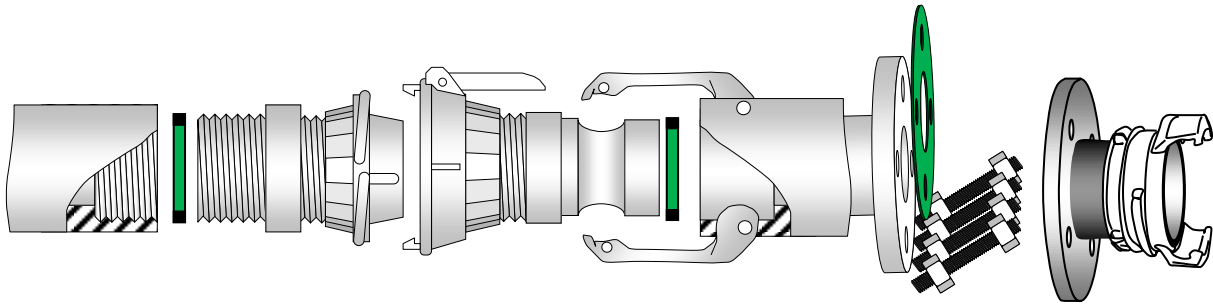

### 12.1. A variety of designs

Several (non compatible) couplings are commonly used in Europe for the (un)loading of chemicals and gasses.

Even more product specific types are used in dedicated supply chains.

This is a significant disadvantage for the flexibility of the European supply chain and has proven to be a 'painful' obstacle for loaders, transporters and discharge locations alike. Every supply chain solution is (sub-) optimized around its chosen coupling. As a result both sites and carriers have a heavy collection of adaptors to go from one type to the other.

This practice is bad for quality as those adaptors and their respective gaskets are not cleaned/replaced on every occasion, bad for safety as the sequencing of connection pieces exponentially increases the risk of spills and bad for environment and economics as the sheer weight of the connection pieces increases the weight of the transport unit which in turn has an unnecessary CO<sub>2</sub>-cost for the transport.

Several attempts to standardize coupling have failed since each coupling has its own specific advantages and disadvantages and change is only possible if there is progress for every particular supply chain.

#### The solution: Quick-connect demountable to flange

solution is to have every quick connect coupling fixed to the transport unit so it can be built-down to a DN80 DIN flange (without compromising the outlet-valve).

In no order of preference the most common couplings are

- BSP
- Flange
- TW
- Guillemin
- KNZ coupling
- Kamlok (Camlok) coupling

For each the text below will describe characteristics, main advantages and disadvantages and conditions for safe use.

Dry disconnect couplings are discussed separately at the end of the chapter.

#### 12.1.1. Glossary

'Quick connect coupling': A fitting that is designed to attach to a line quickly and efficiently. It often consists of a male 'adapter' and female 'coupler' containing a gasket.

'Self-locking' A Self-locking Coupling must positively lock upon closing and must not uncouple until the operator releases the latch. This ensures the connection cannot accidentally open under stress or vibration.

'*Dry disconnect couplings*' are couplings where connector and valve assembly are interlocked such that the valves can only be opened by (or after) fully engaging the hose unit on its matching tank unit.

'*Gasket*' A mechanical seal which fills the space between the steel surfaces of the coupling to prevent leakage made of paper, rubber, silicone, neoprene, nitrile rubber, fiberglass, polytetrafluoroethylene (otherwise known as PTFE or Teflon) or a plastic polymer (such as polychlorotrifluoroethylene).

'*Adaptor*' A short piece of pipe with 2 (usually different types of) couplings on each end to interconnect pipeline systems.

### 12.1.2. Material of construction

---

The material used to make such couplings is very important.

This document describes steel couplings only; PolyPropylene/PolyEthylene couplings of similar design exist but should not be used in a bulk liquid chemicals supply chain (except the KNZ coupling designed for corrosive substances).

The document focusses on (un)loading operations both through the top or via the bottom of the tank, this is commonly done with a flexible hose but an (un)loading arm can be considered too.

## 12.2. Overview of most the common coupling types

---

### 12.2.1. BSP

---

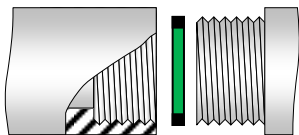

'BSP' is a standard for threaded pipes. BSP, or British Standard Pipe (or parallel) is NOT tapered thread! Parallel threads maintain the same outside diameter throughout, and thus do not form a tighter seal as one goes further down the thread.

Hence the coupling is tightened against a gasket (in the drawing in green).

The male part (thread on the outside) is usually part of the vehicle.

#### 12.2.1.1. Main advantage

---

BSP is fairly common, mostly on Bulk Liquid Container (ISO-tanks), easy to use.

If the coupling is not tight - provided the gasket is not broken - the coupling can be tightened fairly easy.

The thread provides a very strong connection allowing more couplings to be made in series.

#### 12.2.1.2. Main disadvantage

---

At least 6 full turns are necessary to make the coupling, this is not a '*Quick connect coupling*'. The thread itself is quite vulnerable and once damaged cannot be fixed nor replaced. A wrench or spanner is required.

#### 12.2.1.3. Condition of use

---

This coupling is often mistaken for a tapered thread. The use of Teflon tape or other materials in the threads is entirely useless. The coupling is made over the gasket.

### 12.2.2. Flange

---

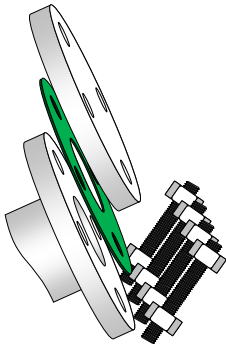

Flanges come in 2 standards ANSI and DIN. The standard flange size for tank/trucks and ISO-tanks is DIN 80 PN 10. In this size the internal diameter of the hole is 80mm or roughly 3 inches and the holes for the bolts are 18mm (fit for an M16 bolt ). PN 10 sets the distance of the 4 holes 160 mm apart (distance centre to centre of the opposite hole). Obviously the coupling is not made by pressing steel: a gasket is to be placed in between. Obviously there is no male or female part, both sides are identical.

#### 12.2.2.1. Main advantage

---

Flange couplings are very common, easy to use.

If the coupling is not tight –provided the gasket is not broken- the coupling can be tightened fairly easy.

The plates provide a very strong basis and the threads provide a very strong connection allowing more couplings to be made in series.

The thread (both nut and bolt) is independent because it is located on the bolt/nut which can be easily replaced if damaged.

#### 12.2.2.2. Main disadvantage

---

This is not a ‘Quick connect coupling’. It does take an additional 2 minutes to align the holes and tighten the nuts. Ensuring each of the 4 holes is filled with a bolt and nut is a behavioural issue. Only using 2 of 4 holes is insufficient and unsafe.

A new gasket has to be used for every operation; this too is a behavioural issue.

#### 12.2.2.3. Condition of use:

---

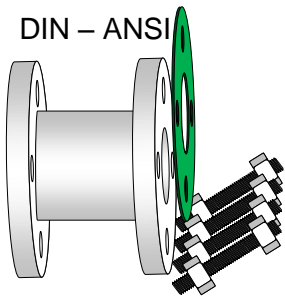

Can be used under any condition.

On some ISO tanks an alternative with slightly different measures is present; this is the US-ANSI standard.

ANSI and DIN are not incompatible but some alterations are necessary such as widening the bolt-holes or reducing the bolt-diameter. Both create a deviation from the applicable standard. The correct solution is to provide a single adaptor DIN – ANSI

### 12.2.3. TW

---

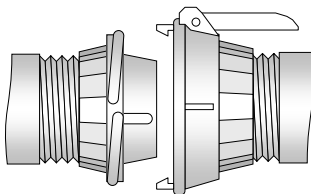

TW or ‘TankWagen’ coupling is also known as the ‘German coupling’. It comes in different sizes of which 3 inch and 2 inch are the most common. As suggested by the name it is mostly used in Germany and in German-linked supply chains.

As seen in the drawing the TW coupling is usually fitted (often glued) onto a BSP coupling or welded on a flange. The female part (the part with the lever) is usually on the truck’s side.

#### 12.2.3.1. Main advantage

---

TW couplings are very common and easy to use.

This is a ‘Quick connect coupling’.

The coupling is actually dependent on the 2 hooks which is fine for normal hose-weight and flow-pressure but insufficient to carry any additional load such as multiple connections in series or the momentum of the gravitational force on a length of pipe.

12.2.3.2. Main disadvantage



If the coupling is not tight it cannot be tightened without risk damaging it irreversibly. The (un)loading has to be stopped, the hose has to be cleared the coupling has to be opened to replace the gasket and start all over. Often the coupling is tightened using a 'cheat-pipe' or even a hammer to squeeze the gasket beyond the forces for which the coupling was designed. This is not permitted and is a behavioural issue.

12.2.3.3. Condition of use

Can be used for coupling hoses or (un)loading arms, not for coupling pieces of pipe as the hooks are not sufficiently strong to cope with the gravitational force.

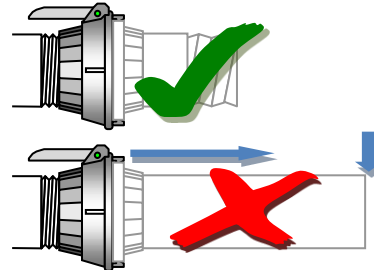

The lever needs to be fully engaged, parallel to the flow-direction

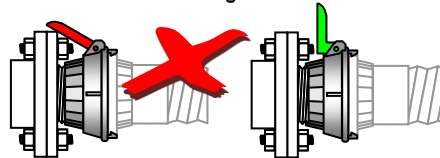

The lever has to be positioned horizontally at the upper ¼ of the line or the lever is to be secured. The spring holding the lever down is not intrinsically part of the mechanism and is known to be unreliable.

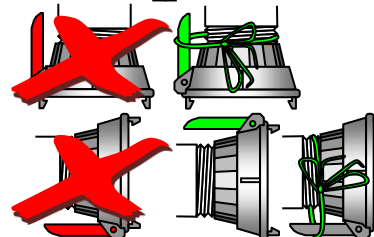

12.2.4. Guillemin

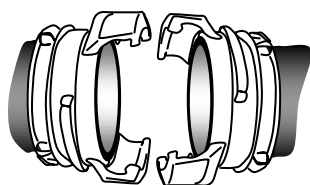

The standard Guillemin-type couplings (aka French couplings or 'raccord pompier'), is a 'Quick connect coupling'.

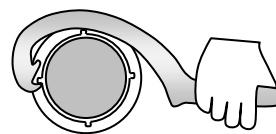

A spanner is required.

12.2.4.1. Main advantage

The Guillemin coupling is a symmetrical coupling, there's no male or female part.

12.2.4.2. Main disadvantage

Making the connection cannot be achieved without having some torque on the hose and coupling. If the coupling is not tight it should not be tightened by applying extra force. The (un)loading has to be stopped, the hose has to be cleared the coupling has to be opened to replace both gaskets and start all over.



The use of a hammer or 'cheater pipe' to snug up the coupling should not be allowed. The coupling relies on friction to hold the pieces in place.



Special 'self-locking' variants with a lever exist but are not common.

#### 12.2.4.3. Condition of use

Should only be used for connecting flexible hoses, not for connecting even short lengths of pipe.

#### 12.2.5. KNZ coupling

KNZ is 'Koninklijke. Nederlandse. Zoutindustrie' or Royal Dutch Salt Industries

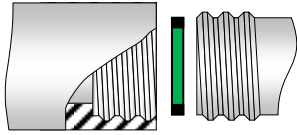

This thread (aka AKZO coupling) is specially designed for transport of inorganic chlorinated acids and alkalines such as hydrochloric acid, sodium hypochlorite. The material (polyethylene) is resistant to specific chemicals. Like BSP the thread is NOT tapered thread! Parallel threads maintain the same outside diameter throughout, and thus do not form a

tighter seal as one goes further down the thread.

Hence the coupling is tightened against a gasket (in the drawing in green).

The male part (thread on the outside) is part of the truck.

#### 12.2.5.1. Main advantage

KNZ-coupling is fairly common in a dedicated supply chain of chlorinated corrosive products often in combination with lined tanks.

The thread itself is less vulnerable compared to the BSP-coupling due to the wider pitch.

#### 12.2.5.2. Main disadvantage

At least 6 full turns are necessary to make the coupling, this is not a 'Quick connect coupling'.

Once damaged the thread cannot be fixed and needs to be replaced.

#### 12.2.5.3. Condition of use

Used only in specific supply chains.

#### 12.2.6. Kamlok (Camlok) coupling

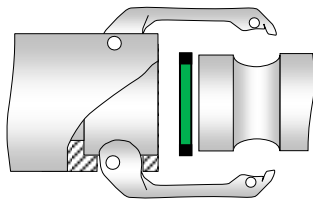

This coupling is not widely used in Europe for bulk liquids but as it is widely used in the US and with IBCs it is worth mentioning in this overview. The coupling is tightened against a gasket (in the drawing in green).

The male part (without the arms) is usually part of the tankcontainer, IBC or flexi-bag (flexi-tank).

#### 12.2.6.1. Main advantage

It's simple, easy to use. The coupling has no torque on the coupling or the hose.

#### 12.2.6.2. Main disadvantage

The coupling is kept in place by friction so for service in dangerous goods the arms need to be secured. Self-locking variants exists.

The male part which makes the seal with the gasket can easily be damaged.

The coupling is not desirable for high pressure unloading.

#### 12.2.6.3. Condition of use

It is an easy but not a very reliable coupling, used only in specific supply chains and mostly for non-dangerous goods.

For pressurized unloading the Kamlock coupling can be used for the air/nitrogen pressure hose, not for the product hose.

## 12.3. The solution: Quick-connect demountable to flange

In conclusion the safest and strongest coupling is the Flange coupling but this is the one that is also more cumbersome to operate.

Still, it has significant advantages over other non-quick-connect couplings such as BSP. Both Guillemín and TW have some common and some specific disadvantages and advantages. The main complicating factor is that both are commonly used and neither has a clear advantage over the other.

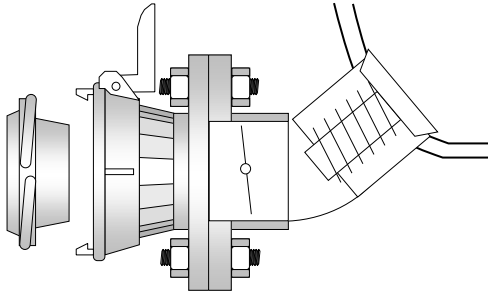

Extending with anything but a flexible hose after TW or Guillemín is not recommended.

In order to ensure any loaded truck or container can be coupled safely, an accessible DIN 80 PN 10 flange should be present between the outlet-valve and the cap so that the coupling fitting the cap (usually TW or Guillemín) can be fairly easily removed if needed.

As such a truck can operate for many shipments in a TW-region where the TW coupling can be used. The coupling can be removed (built-down to the flange) on the odd occasion the customer requires a different coupling.

Equally this truck can operate for many shipments in a Guillemín-region where the Guillemín coupling can be used until the coupling is to be removed (built-down to the flange) in the odd occasion the customer requires a different coupling.

Any unloading site using hoses with other couplings than a DIN 80 PN 10 flange should have one simple adaptor available. (For TW-sites it would be a flange to TW connector, for Guillemín-sites this should be a flange to Guillemín coupling.)

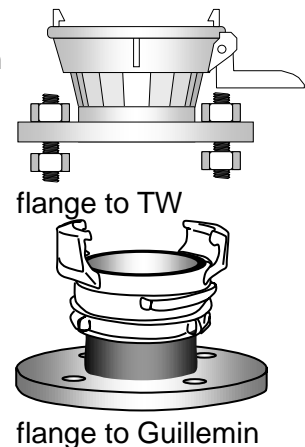

Only when the tank-coupling is different from the hose-coupling the driver will build down the connection to the flange and connect the site's adaptor to his vehicle.

This logic is not limited to TW and Guillemín, it fits any quick-coupling imaginable.

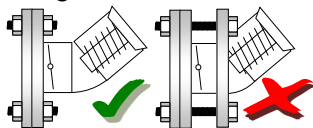

In order for the flange to be accessible the bolts cannot be used at the same time for the outlet valve. In removing those bolts the tightness of the valve is lost which is not acceptable.

### 12.3.1.1. Conclusion

Every truck or container should have a useable DIN flange type DN 80 PN 10 behind the 2<sup>nd</sup> valve. Bolted to this flange any (quick-connect)-coupling fit for the specific supply chain can be fixed. When needed the site's flange-to-coupling connection-piece will be fixed by the driver prior connecting the site's hose.

## 12.4. Dry disconnect couplings

Dry disconnect couplings (also often described as 'dry-break') allow you to disconnect the hose without making it liquid-free (without blowing the line).

This would then cause the pipe between the coupling and the foot-valve to remain full of liquid during transport. This is not in contradiction with ADR but is definitely not an appropriate way to transport dangerous goods.

If dry disconnect couplings are used they should still be drained or blown prior disengaging.

In the drawing a DDC (Dry Disconnect Coupling) (male) flanged to the vehicle. Butterfly valve is now optional. Equipped with blind cap.

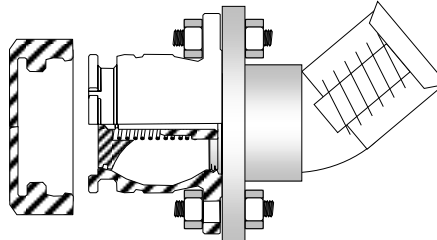

Upon engaging the connection the internal mechanism automatically opens a valve in both ends of the connection allowing product to flow through the connection.

### 12.4.1.1. Main advantage

These are quick-connect couplings that minimize opportunity for human error. (No bolts can be over-under tightened and or missed, no thread wire can be damaged, no gasket is to be replaced – or forgotten – no hammer need be used)

### 12.4.1.2. Main disadvantage

These are expensive couplings.

They only serve their purpose if the connections are allowed to stay on the transport equipment effectively limiting the benefit to dedicated transport.

If damaged, the connection needs to be removed (e.g. by removing the bolts of the flange) if the connection is used without emptying the pipe before uncoupling, product will be released.

Hence safe use requires blowing the line before disengaging the connection! This is a behavioural issue.

The coupling cannot be routinely inspected for cleanliness.

For some designs, when open, the internal mechanism still hinders flow significantly compared to butterfly or ball valves. (This latter disadvantage not with the ball-valve DDC)

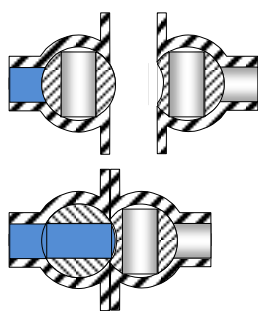

Both ball valves are locked in closed position. The engaging mechanism prevents them from being turned

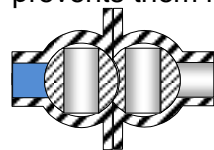

Once engaged the turning of the ball valves is unlocked.

The left ball valve can rotate where the right one has a cavity to allow this. Turning the ball also locks the coupling.



The right ball valve can now rotate where the open end of the left ball valve allows this. Product flow is unhindered.

### 12.4.1.3. Condition of use

Also Dry-disconnect-couplings should be mounted on a Din 80 PN 10 flange for maintenance purposes. The coupling is not to be removed in routine operations because that would eliminate the very purpose of the coupling.

Not to be used for products that crystallize or solidify at ambient temperatures.

## 12.5. Pressurized air couplings

---

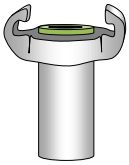

For connecting pressurized air or nitrogen, ...  
Camlock. ( $\frac{1}{2}$ ,  $\frac{3}{4}$  or 1 inch) and express coupling (only 1 size) are used  
The express coupling is the preferred option on new equipment.

## 12.6. Vapour-return couplings

---

For Vapour return usually the same coupling as the liquid is used but with a smaller opening, usually 1 1/2 or 2 inch.

2 inch is the preferred standard as 1 inch may cause a flow restriction which might create under-pressure in the container which is a significant risk.

## 12.7. Hoses and gaskets

---

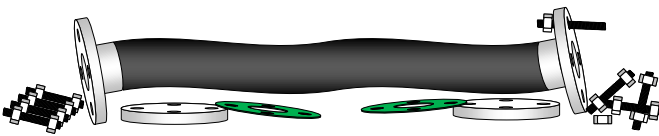

The hose is the weakest link between the certified tank and the storage installation.

Annual testing and visual inspections are common practice.

Ideally all hoses are product- or product-range dedicated and owned and maintained by the delivering/receiving site.

Hoses on trucks are much more difficult to control and create supplementary weight (and consequently imposes an unnecessary CO<sub>2</sub> burden on the supply chain).

All hoses and gaskets used to (un)load have to be made of materials suitable for the products handled. These have to be resistant to the pressure and temperatures used.

It is obvious that the owner of the hose:

- has to undertake a risk analysis on the materials used based on the product properties / pressure / temperature.  
For this reason the risk assessment on a site with controlled environment is much better defined than the comparable assessment if the hose is owned by the carrier.
- has a specification sheet proving the compatibility of the hose and gasket material.
- has proper working, cleaning, inspection and maintenance instructions.

Prior to connecting, the hose and gasket are to be visually checked for damage or wear and tear.

Spare gaskets for every coupling need to be available at all times.

See '[Roles and responsibilities](#)'

## Contact list



**Steven Beddegenoots**  
Global SHERQ manager SC  
SABIC SBU Chemicals  
M +31 6211 699 79  
steven.beddegenoots@sabic-europe.com



**Judith Kleinen**  
Manager Land Transport &  
Spot Shipping  
SABIC SC Chem Europe  
T +31 46 722 2273  
M +31 6 134 282 55  
judith.kleinen@sabic-europe.com



**Jan Hendrik Leopold**  
SSHEQ Manager  
R.M.I. Global Logistic Services  
T +31 10 283 11 00  
janhendrik.leopold@nl.rmi-global.com



**Luc Van de Velde**  
Logistics Safety Manager  
Ineos Olefins & Polymers Europe  
T + 32 3210 36 47  
M + 32 475 27 23 31  
Luc.vandevelde@ineos.com



**Philippe Neefs**  
Distribution Safety Specialist  
Chevron Phillips Chemicals Int N.V.  
T+32 2689 1265  
F+32 2689 1307  
neefspm@cpchem.com



**Evert de Jong**  
European HSSEQ Manager  
De Rijke Group  
M+31 181 654 292  
M+31 653 789 646  
Evert.deJong@derijke.com



**Maayke Van Noort**  
ES&S Transportation Manager Benelux  
Dow Benelux BV  
T+31 115 671 334  
mjevannoort@dow.com



**Marc Cabuy**  
EMEAF Liquids Logistics SSHE Advisor  
ExxonMobil Chemical  
T+ 32 2 722 4063  
marc.cabuy@exxonmobil.com



**Steve Rowland**  
SHEQ Manager, UK, Europe and Americas  
Suttons Transport Group  
T+44 151 420 2020  
M+44 7713 230 047  
stephen.rowland@suttonsgroup.com



**Rob Montfoort**  
HSSE Country Specialist  
Shell Chemicals Europe B.V.  
T+ 31 10441 6291  
M+31 655 125 876  
rob.montfoort@shell.com



**Jacques Declercq**  
Secretary General  
M+32 475 451 457  
Jacques.declercq@bacd.be



**Colin V Humphrey**  
Managing Director  
Responsible Care Coordinator  
T +32(0)2 741 86 81  
M + 44 (0) 781 732 5834  
colinvhumphrey@ecta.com



**Victor Trapani**  
SQAS Manager  
Cefic  
T+32 2676 7385  
M+32 499 580 610  
vtr@cefic.be



**Justin Lemmens**  
Senior Sales Manager  
LKW WALTER Internationale  
Transportorganisation AG  
T+43 5 7777 4339  
M+43 664 85 82 401  
lemmens@lkw-walter.com



**Peter J C Newport**  
Chief Executive Officer  
Chemical Business Association  
T +44 (0) 1270 252800  
M +44 (0) 7786 515407  
peter.newport@chemical.org.uk



**Jos Verlinden**  
Director Transport and Logistics  
Cefic  
T+32 2676 7395  
M+32 474 989033  
jve@cefic.be



**Marc Twisk**  
Project manager  
Transports Vervaeke  
T+32 2481 7693  
M+32 498 580 608  
mtw@vervaeke.com

## Part C: Annexes

### 1. Annex 1: Example Risk assessment for Bulk Solids Unloading sites

Nr	The unloading area and equipment	Risk	P	E	S	R	Possible Mitigation measures
1	The unloading area is located on the public road	a raised silo/ container can topple sideways when it is hit by another vehicle causing injury or death to people passing by or damage equipment, vehicles etc.	1	6	15	90	change unloading location
2	Trucks have no easy access to the unloading area (with obstructions)	collision risk	6	6	3	108	make sure that there is a clear, safe access with sufficient room for the vehicle to manoeuvre
3	reversing to the unloading point in an area where pedestrians or vehicles are moving	collision risk	6	6	3	108	
4	The surface of the unloading area is not firm and uneven	toppling sideways of silo/ container in case of instable underground	3	6	15	270	
5	The surface of the unloading area cannot withstand an axle load of 12 ton	toppling sideways of silo/ container in case of instable underground	3	6	15	270	
6	The surface of the unloading area is not properly drained and not free from trip hazards	personal injury (slipping, tripping)	6	6	3	108	
7	There is an overhead obstruction (pipelines ) which may be hit by the silo/ container if it is tipped in its highest position.	damage to equipment, product release etc. when silo/ hits pipelines cables in raised position	6	6	3	108	
8	The unloading area has no lighting adequate for discharge operations during the hours of darkness	collision risk, personal injury	3	6	3	54	
9	The unloading area has no well-marked earthing connection	electrostatic discharge, chock driver	3	6	1	18	
10	No spill kit is available in case of leakage of hydraulic oil, diesel or cooling water.	environmental damage	3	6	1	18	
11	Within an area of 13 meter left and right of the truck (and in addition 5 m behind a container truck) , there is vulnerable equipment (pipelines with dangerous goods)that can be damaged in case the trailer would topple over sideways.	damage to equipment. Product spillage. Unit outage	3	6	15	270	All vulnerable equipment must be taken out of the danger zone or must be properly protected (e.g. by means of a steel structure)
12	Within an area of 13 meter left and right of the truck (and in addition 5 m behind a container truck), there are vehicle movements	damage to equipment. Personal injury	3	6	15	270	fence off the area during unloading operations. If not possible, carry out a specific risk assessment
13	People are not allowed to enter the area of 13 meter left and right of the tipping trailer	personal injury when silo/ container topples sideways	3	6	15	270	fence off the area during unloading operations. If not possible, carry out a specific risk assessment
14	The intake point to the silo is not readily accessible to connect the hose to.	personal injury	3	6	1	18	
15	The intake point is not marked with the silo nr and is not locked . The driver receives no document with the silo nr on it. The operator does not indicate where to connect to	unloading into wrong silo (Quality risk)					The connection of the hose to the inlet line is done by the operator
16	no adequate Working At height facilities for sampling from the top	Fall from truck	6	6	7	252	

P= Probability that the risk occurs	
0	Theoretically impossible
0,1	Virtually impossible
0,2	Practically impossible
0,5	Thinkable but unlikely
1	Only borderline possible
3	unusual but possible
6	occurrence very well possible
10	occurrence to be expected

E= exposure to the risk	
0	No exposure
0,5	Very rarely -once a year
1	rarely - a few times /y
2	Unusual - monthly
3	Occasional - weekly
6	Frequently - daily
10	continuously

S = Severity : possible damage and consequences			
0		No damage	
1	Minor	First aid	< 250 €
3	Important	adapted work	< 2500 €
7	Serious	Days away from work	< 25 K€
15	Very serious	1 fatality	< 250 K€
40	Disaster	multiple fatalities	> 250 K€

R = Risk index = P x E x S		
0		No Risk
1	<= 20	Probably acceptable risk
2	20 < R <= 70	requires attention
3	70 < R <=200	requires improvement
4	200 <R <= 400	immediate measures required
5	R > 400	consider to stop activities

## 2. Annex 2: Pictorial examples of Access/ Egress to the (un)loading area

In order to avoid collisions with pedestrians, vehicles or fixed structures, trucks must have a free and unobstructed access to the (un)loading place.

- Adequate space to manoeuvre
- No obstructions
- No need to reverse a long distance (except with the help of an operator/banksman)
- Adequate signage (e.g. one way roads, warning: crossing forklifts etc.)

### 2.1. Some examples of poor housekeeping practices

---



### 2.2. Example of narrow access route

---



### 2.3. One example of segregation between truck and other traffic

---



There must be free egress from the loading/ unloading area. If the truck driver has inadequate visibility when coming onto a public road, he must be assisted by an operator.





## 3. Annex 3: Examples Behaviour Based Safety Observation reports

Enhancing safe behaviour is all about systematic and structured observation. Based on the type of activity and the level of risk involved, a specific interval can be determined to perform these observations. Usually a checklist is used in order to guide the observer to each task, as they have been allocated to each participant in the (un)loading procedure of the site.

Here is an example of such a checklist which has been designed for the typical activities that take place during a (un)loading process. You can use (parts of) this list as it is or you can adapt the list to the situation you are responsible for. You will note that the roles and responsibilities of operator and driver, as they have been allocated by the guideline in [Operational responsibilities](#) are integrated into each step of this list. Again it is up to the user to determine if this is the allocation of responsibilities that is applicable to the site and (un)loading procedure.

This checklist is an example, but we invite you to make use of a checklist, both for practical reasons as well as for documentation purposes.

Site/ area:	Observer:
Date:	Activity:

Observation		Operator	Driver	Surveyor	Comments / actions to be taken	SAFE	UNSAFE
<b>1</b>	<b>Transport equipment</b>						
1.1	Check of transport equipment	X	X				
<b>2</b>	<b>Site instructions</b>						
2.1	Operator adheres to site rules and is example for driver	X					
2.2	Operator witnesses whole (un)loading activity	X					
2.3	Driver reports to gate and received site instructions		X				
<b>3</b>	<b>On-site driving and parking</b>						
3.1	Safe driving behaviour		X				
3.2	Parking instructions followed	X	X				
<b>4</b>	<b>Personal protective equipment (PPE)</b>						
4.1	Operator and driver wearing required PPE	X	X				
<b>5</b>	<b>Emergency preparedness</b>						
5.1	Site safety equipment location indicated and noticed	X	X				
<b>6</b>	<b>Documentation, marking and labelling</b>						
6.1	Documentation, labelling and marking checked	X					
6.2	Documentation, labelling and marking complete and in compliance		X				
<b>7</b>	<b>Product samples</b>						
7.1	Sample present and handed to operator		X				
7.2	Sample present and handed to driver	X					
7.3	Sample taken from land tank			X			
7.4	Sample taken from transport equipment			X			
<b>8</b>	<b>Working at height</b>						
8.1	Site instructions followed	X	X				
8.2	Sufficient fall arrest present	X	X				
<b>9</b>	<b>Tank capacity</b>						
9.1	Capacity of land tank checked	X					
9.2	Capacity of transport tank checked	X	X				
<b>10</b>	<b>Equipment under pressure</b>						
10.1	Pressure checked before making or breaking connection	X	X				
<b>11</b>	<b>Loading of liquids in multi compartment tanks</b>						
11.1	Load plan checked with capacity of compartments	X	X				

Observation		Operator	Driver	Surveyor	Comments / actions to be taken	SAFE	UNSAFE
11.2	Rules checked with regard to the separation of dangerous products	X					
<b>12</b>	<b>Hoses and other equipment</b>						
12.1	Hoses and other equipment to be used for loading/discharge checked for fitness/cleanliness	X	X				
<b>13</b>	<b>Connections</b>						
13.1	Site connections properly labelled	X					
13.2	Site connections properly fitted to the storage tank	X					
13.3	Vehicle equipment properly fitted		X				
<b>14</b>	<b>Permission to (un)load</b>						
14.1	Approval to (un)load properly communicated and respected	X	X				
<b>15</b>	<b>Vehicle restrictions</b>						
15.1	Maximum weight checked and respected	X	X				
<b>16</b>	<b>Disconnection</b>						
16.1	All valves checked to be closed and hoses to be pressure free before disconnection	X					
16.2	All valves and manlids checked to be closed and hoses to be pressure free and free from rest product before disconnection		X				
16.3	Transport tank free of residue after discharge	X	X				
16.4	Transport tank free of pressure after discharge	X	X				
<b>17</b>	<b>Reporting of unsafe situations, near misses and incidents</b>						
17.1	Unsafe situations and near misses, present or past, with regard to the(un)loading situation reported	X	X				
<b>18</b>	<b>Stowage, securing and segregation of packed goods</b>						
18.1	Already stowed packages checked	X	X				
18.2	Stowage of new packages checked	X	X				
18.3	Rules regarding separation of products (food, dangerous goods etc.) checked and respected	X					
18.4	Vehicle properly prepared for (un)loading		X				

Examples specific 'At risk' behaviours.

<b>Forklifts</b>	1	Driving a forklift without adequate visibility to crossing traffic
	2	Failure of FL driver to keep enough distance with other forklift
	3	Failure to lower the mast before driving off
	4	Failure to report regular collisions of forklift masts with cross beams in warehouse door openings (led to an incident whereby cross beam fell down)
	5	Failure to use a FL in the right way (transporting people, pushing with forks against bagging machines, closing container doors, pushing forward a pallet, driving forward with inadequate visibility...)
<b>Bagging lines / de-bagging</b>	6	Failure to prepare maintenance work, failure to do a proper risk assessment, failure to complete the PTW properly
	7	Failure to report difficulties to move a bagging machine, and putting hand under machine to remove pellets led to an incident
	8	Trying to move by hand a blocked pallet on a conveyor belt
	9	Bypassing critical safety devices: light curtain
	10	Failure to ask for a PTW and to do a risk assessment when repairing the hydraulics of a scissor lift
	11	Failure to report unsafe system to lift mobile ramp (has led to an incident)
	12	Failure to secure the container doors in case of high winds
<b>Loading bulk</b>	13	Failure to check proper closure of rear man entry hatch silo truck before loading
	14	Chain of chain valve hit loading operator because he was performing the job (loading bulk truck) too quickly
	15	Failure to report that securing pin of rear man entry hatch was broken. Driver kept hatch open during inspection by operator
	16	Failure to put safety ladders back in place before driving off
	17	Going into the empty silo truck without a tank entry permit

<b>Unloading bulk</b>	18	Failure to put safety clamp on hose connection( resulted in spillage)
	19	Raising the silo in one go instead of several stages
	20	Driver climbing on top of container for opening hatches on parking place before entering the customer's site
	21	Failure to check twist locks, landing legs etc. before discharge
<b>Loading packed goods trucks</b>	22	Failure to do a proper load securing of the cargo
	23	Failure to use the right tool to put the horizontal planks in the holders of the truck
	24	Failure to apply and to enforce forklift segregation rules
<b>Stacking pallets</b>	25	Failure to use the safety steps
	26	Failure to observe stacking properties of pallets with hot product and double stacking along pedestrian walkways
<b>Product transfer</b>	27	Failure to put 'no stacking' labels on pallets which are not stackable
	28	Failure to assure that bottom valve of receiving silo is closed before transfer
<b>Driving (on the road and on site)</b>	29	Failure to do a check during transfer operations
	30	Failure to adapt speed (roundabouts, in sharp curves.)
	31	Driving when fatigued
	32	Failure to wear seat belt
	33	Failure to do a brake test after coupling a dock spotter to a trailer
<b>Slipping/ falling</b>	34	Not respecting the traffic safety rules
	35	Unsafe driving
	36	Failure to remove spilled product from the ground (incident)
	37	Failure to report / remove an oil spill (incident)
	38	Failure to remove ice and snow from road (incident)
<b>Working at height</b>	39	Failure to report obstructions on the floor in a silo farm led to an incident
	40	Failure to remove obstructions on the ground (cables and other objects)
	41	Failure to wear fall arrest equipment (life line system) when working at height
	42	Failure to use fall arrest equipment in the right way
	43	Failure to use stepladders
	44	Attaching life line to the truck
	45	Failure to use the handrail and being in a hurry when walking up a staircase
	46	Failure to use ladders/ platforms in the right way
	47	Ladder used not suitable for the work (too short, damaged.)
	48	Working at heights without proper fall protection
	49	Carrying material up ladders
<b>Lifting</b>	50	Throwing material from above grade to ground
	51	Failure to maintain 3 point contact while ascending a ladder
	52	Lifting beyond physical capacity
<b>Hands and fingers</b>	53	Lifting in awkward position
	54	Using chain hoist that was under rated for the job
<b>Falling objects</b>	55	Putting hands and fingers between objects
	56	Failure to secure material that could fall from above
	57	Failure to install a barrier to protect workers below a work area
	58	Working under loads without protection
<b>General</b>	59	Failure to cover a floor opening
	60	Working near an opening without fall protection
	61	Trying to save time by taking a short cut
	62	Failure to confirm competency of worker prior to assigning work (e.g. lift platform)
	63	Not respecting the site safety rules (e.g. smoking)
	64	Aggressive behaviour
	65	Entering restricted area's without permission
	66	Moving heavy objects without proper protection (e.g. removing FFS foil reels from pallets)
67	Failure to use the right safety knife for cutting cardboard	
	68	Working under a scissor lift, Forks of a forklift etc. without securing the lift in its position

## 4. Annex 4: Roles and Tasks for load securing in Cargo Transport Units

Process/ Stage	Task/Activity	Principal	Carrier
Management responsibilities	Carry out risk assessment	•	•
	Document packaging specifications (including stacking rules)	•	
	Define CTU requirements (type, specifications, LTL cargo rules)	•	
	Determine and document CTU weight/axles limits		•
	Agree load distribution plans (number of packages/gross weight limits/axle weight limits)	•	•
	Agree on supply of cargo securing material	•	•
	Develop good securing and stowage practices for the agreed load plans	•	•
	Define and agree working instructions (who will do what)	•	•
	Document operational procedures/instructions	•	•
	Train and instruct employees involved	•	•
Offering CTU 'Fit for Load'	Select CTU in line with principal's requirements		•
	Ensure good condition of CTU (load floor, side walls, curtains, lashing points, headboard)		•
	Fulfill LTL cargo rules (including segregation rules)		•
	Ensure that LTL cargo is secured and stowed adequately		•
	Provide re-usable securing material (e.g. lashings, friction material, rigid protection edges,...)		•
Pre-loading checks/tasks	Instruct driver on specific safety instructions (e.g. interaction during loading operation)	•	
	Check weight of CTU with respect of routing/model/legislation/truck type	•	•
	Adjust quantity to be loaded taking into account the weight of the CTU	•	
	Select one of previously agreed load plans	•	
	Immobilize CTU	•	•
	Open CTU		•
	Check if CTU meets requirements and is safe to load	•	
	Check availability and condition of the cargo securing material	•	
Confirm agreement on loading / securing operational procedure	•	•	
Loading/securing operation	Load according to selected load plan	•	
	Ensure correct segregation of cargoes	•	
	Supply additional cargo securing material (e.g. air bags, sheets, one way straps,..)	•	
	Application of blocking and bracing	•	
	Application of lashing as agreed by the management in the working instructions		•
Post-loading checks/tasks	Check the applied cargo securing (blocking, bracing and lashing)	•	•
	Close CTU		•
	Apply seal if applicable and note on the transport documentation	•	
	Sign off loading document (confirming loading and cargo securing is correctly carried out)	•	•
	Check and correct cargo securing during transport (e.g. partial loading /unloading)		•
<ul style="list-style-type: none"> <li>Under all circumstances applicable national and international (e.g. ADR) regulations take precedence on these general guidelines and should be implemented.</li> <li>It is not the purpose of this guideline to define liabilities in case of damage to the transported goods.</li> <li>For FCA (Free Carriage/see Incoterms) consignments the above matrix may not apply. In this case the respective roles and tasks need to be agreed between the principal (customer), the management of the loading site and the carrier prior to the transport operation.</li> <li>In case the driver is not present during loading, the loader must fulfil the roles initially assigned to the driver (e.g. containers, swap bodies, drop and swap,...).</li> </ul>			

## 5. Annex 5: Hierarchy and lists of applicable legislation

This guideline gives a generic overview of most relevant legislative and regulatory requirements for safe (un)loading of chemicals.

Links between the legislation and the application in our activities is also provided.

Different companies are involved in (un)loading of chemicals, this can be a chemical plant, a terminal, a warehouse, a transport company. All employers in the supply chain are responsible to offer their employees a safe and healthy working environment.

In order to ensure safe operations it is very important that employers also give the information to employers of non-site companies, like transport companies.

The legislation is divided into different parts:

1. Health and safety
2. Process safety
3. Environment
4. Transport

The first part of this chapter gives a general overview of the types of legislations and standards you can expect in this area. The second part briefly explains the content of the legislations.

### 5.1. Health and Safety

---

Health and safety 89/391/EC

- Risks
  - Risk Assessment Art. 6 § 2
  - Optimise work/workers environment Art.6 § 3
  - Health and safety coordination Art 6 § 4
- First aid, fire fighting, evacuation, serious and imminent danger
  - First aid organisation Art.8 § 1 & 2
  - Information and instructions Art 8 § 3 & 4
- Incidents & accidents
  - Information and reporting system Art. 9)
- Worker information
  - Own workers and/or their representatives Art. 10 § 1
  - Employers from outside undertakings Art 10§2
- Training & specific instructions
  - Own workers Art. 12 § 1
  - Workers from outside undertakings Art. 12 § 2

The aim of [Directive 89/391/EC - OSH 'Framework Directive'](#) is to introduce measures to encourage improvements in the safety and health of workers at work.

It is of fundamental importance as it is the basic safety and health legal act which lays down general principles concerning the prevention and protection of workers against occupational accidents and diseases. It contains principles concerning the prevention of risks, the protection of safety and health, the assessment of risks, the elimination of risks and accident factors, the informing, consultation and balanced participation and training of workers and their representatives.

On the basis of this 'Framework Directive' a series of individual directives were adopted. The Framework Directive with its general principles continues to apply in full to all the areas covered by the individual directives, but where individual directives contain more stringent and/or specific provisions, these special provisions of individual directives prevail.

The specific situation for loading and unloading is the cooperation between different employers. The directive states in article 10 point 2 how to handle this. Art 10 point 2 obliges employers to give information to employers of outside undertaking.

See the Communication from the Commission to the European Parliament, the Council, the European Economic and Social Committee and the Committee of Regions on the practical implementation of [the provisions of the Health and Safety at Work](#) Directives 89/391 (Framework), 89/654 (Workplaces), 89/655 (Work Equipment), 89/656 (Personal Protective Equipment), 90/269 (Manual Handling of Loads) and 90/270 (Display Screen Equipment)

## 5.2. Process Safety

---

- Management systems
  - Risk Assessment
  - Management of Change
  - Learning from Incidents
- Fire Safety
  - Fire safety Directive
  - ATEX Explosive Atmospheres Atex 118a; Dir\_1999\_92
- Equipment requirements
  - Safety in Pressure Vessels EN 13445 (97/23/EC)
  - Machine directive 2006/42/EC
  - CE marking 93/68/EC
  - Design of Installations different standards
- Storage requirements
- local legislation

General:

Process Safety directives are not available in EU. In general process safety management is a set of tools that focuses on preventing releases of any substance that have a high risk to the environment like toxic reactive or flammable liquids or gasses. A risk analysis on potential release of chemicals, the effect of such a release and the mitigating measures should ALWAYS be assessed, also when a material is not classified.

For every country different standards can apply and also different ways are available to present to guidelines.

For UK : <https://www.gov.uk/browse/business/manufacturing/manufacturing-regulations>

## 5.3. Environment

---

- Emissions to air, soil and water
  - Directive 2010/75/EC (Integrated pollution prevention control - IPPC)
    - Directive 2008/50/EC (Air Pollution)
    - National Air Emission legislation
    - Proposal for a Soil Framework Directive (COM(2006) 231)
    - National Soil pollution legislation
    - Water Framework Directive 2000/60/EC
    - National Water pollution legislation
- Waste Control
  - 2008 EU Waste Framework Directive
    - National Legislation on Waste Control
- Noise Control
  - Environmental Noise Directive 2002/49/EC
    - National Legislation on Noise Control

The Environment legislation is divided in different aspects/ compartments:

General:

The general information can be found on the EU website:

[http://ec.europa.eu/environment/sme/legislation/legislation\\_en.htm](http://ec.europa.eu/environment/sme/legislation/legislation_en.htm)

- Emission to air, soil and Water
- Air quality, emissions trading and noise
- Chemicals (REACH)
- Energy
- Environmental management (EMAS, Life Cycle Assessment, CSR)
- Greener products (Green Public Procurement, EU Ecolabel, Integrated Product Policy, Eco-design, WEEE, RoHS, ELV, EuP )
- Water
- Soil
- Containment (Nederlandse Richtlijn Bodembescherming = NRB zit ook in PGS 15)
- Waste control
- Waste
  - Cleaning of transport equipment
  - Empty packaging
- State aid for environmental protection

#### 5.4. Transportation

---

- Transport Different Directives available
  - Load Securement
    - ADR 7.5.7.1
    - Cargo Securing Guidelines
    - For class 2 load securing (IGC Doc 52/06/E)
  - CMR, Contract for International Carriage of Goods by Road
  - ADR
    - Responsibilities ADR 1.4
    - Packing Requirements
    - ADR chapter 4 and chapter 8
    - Provision concerning the condition of (un)loading and handling ADR Chapter 7
    - Design of Installations different standards
  - Country legislation on transport via road

##### 5.4.1. GENERAL on Transport legislation:

Transport is regulated both on a national and European level. A general overview on the Regulations for the different modes with EU-directives is available at following website:

[http://europa.eu/legislation\\_summaries/transport/index\\_en.htm](http://europa.eu/legislation_summaries/transport/index_en.htm)

##### 5.4.2. Load securing

---

See ADR 7.5.7.1 related to the stowage

- General cargo :
  - European Best Practice Guidelines on Cargo Securing for Road Transport
  - [http://ec.europa.eu/transport/road\\_safety/vehicles/doc/cargo\\_securing\\_guidelines\\_en.pdf](http://ec.europa.eu/transport/road_safety/vehicles/doc/cargo_securing_guidelines_en.pdf)
  - The requirements of paragraph 7.5.7.1 of ADR are deemed to be complied with if the cargo is secured in accordance with standard EN 12195-1:2010
- For class 2 receptacles :
  - Load securing of class 2 receptacles – IGC Doc 52/06/E
  - [http://www.mobilit.fgov.be/data/route/adr/Doc\\_52\\_06\\_E.pdf](http://www.mobilit.fgov.be/data/route/adr/Doc_52_06_E.pdf)

For rail see

- [www.gcubureau.com](http://www.gcubureau.com), January 2013 appendix 9, code 7.x.x and following
- “loading guidelines” of RIV at [www.uic.org](http://www.uic.org) version January 2013  
<http://www.uic.org/etf/rivric/riv-ric.pdf>

### 5.4.3. CMR Convention

---

[CMR : Convention on the contract for International Carriage of Goods by Road](#)

### 5.4.4. ADR

---

European Agreement concerning the International Carriage of Dangerous Goods by Road.

- Responsibilities of the parties involved:
  - See ADR 1.4 : Safety obligations of the participants
- Packing and Tank requirements
  - Part 4: Packing and tank provisions – use.
  - Part 6 : Requirements for the construction and testing of packagings, intermediate bulk container (IBCs), large packagings, tanks and bulk containers
- Provisions concerning the conditions of (...) unloading and handling
  - See ADR chapter 7

### 5.4.5. Country specific legislation

---

There is country specific legislation such as:

- Transportation of goods and services.
- Legislation on hose testing, maintenance and use.

## 5.5. Standards

---

Many standards are applicable to (un)loading operations.  
Below a non-comprehensive list is given.

Standard	Description
EN 12115:2011	Rubber and thermoplastics hoses and hose assemblies for liquid or gaseous chemicals. Specification (British standard)
ISO/DIS 5772	Rubber and plastic hoses and hose assemblies for measured fuel dispensing systems -- specification 40.00 ISO/TC 45/SC 1
ISO 5772:1998	Rubber hoses and hose assemblies for measured fuel dispensing -- specification
ISO/DIS 2929	Rubber hoses and hose assemblies for bulk fuel delivery by truck -- specification
ISO 2929:2002	Rubber hoses and hose assemblies for bulk fuel delivery by truck -- specification
EN 1761:1999	Rubber hoses and hose assemblies for fuel truck delivery. Specification
EN 1762:2003	Rubber hoses and hose assemblies for liquefied petroleum gas, LPG (liquid or gaseous phase), and natural gas up to 25 bar (2,5 MPa).
Din 2825-1	Rubber hose assemblies for steam and hot water - general requirements
Din 2827	Hose assemblies of stainless steel for chemical products
ISO 7751:1991 (reviewed 2009)	Rubber and plastics hoses and hose assemblies -- ratios of proof and burst pressure to maximum working pressure
BS EN 682:2002	Elastomeric seals. Materials requirements for seals used in pipes and fittings carrying gas and hydrocarbon fluids



## 6. Annex 6: Best Practice Guidelines

The following Cefic / ECTA Best Practice Guidelines are available online

---

ECTA: [www.ecta.com](http://www.ecta.com)

[Behaviour based safety guidelines for safe driving of road freight vehicles](#)

[Best practice guidelines for the safe working at height in the chemical logistics supply chain](#)

[ECTA guidelines for equipment for the transport of dry bulk cargo, to be discharged by tipping](#)

[Best practice guidelines for the safe use of 'lined' ISO box containers for movement of dry bulk products](#)

[Recommendations for tipping silo trailers](#)

[Guidelines for transport equipment used for chemical packed cargo](#)

[How to reduce time spent by drivers on site and improve their treatment](#)

[ECTA-Cefic guidelines for standardized coding of transport events - ECTA codes](#)

---

---

Cefic: [www.cefic.org](http://www.cefic.org)

[Behaviour based safety guidelines for safe driving of road freight vehicles](#)

[Best practice guidelines for the safe working at height in the chemical logistics supply chain](#)

[Guidelines for transport equipment used for chemical packed cargo](#)

[How to reduce time spent by drivers on site and improve their treatment](#)

[ECTA-Cefic guidelines for standardized coding of transport events - ECTA codes](#)

---

## 7. Annex 7: Examples of Risks and Risk mitigation for (un)loading operations

### 7.1. Technical requirements (un)loading places

This chapter gives a brief overview of possible technical measures that can be taken to mitigate the risks that can occur at an (un)loading place. Examples of risks can be: overflow, over pressure, under pressure, exposure to product, exposure to vapours, fire/explosion, chemical reactions, unwanted movement of vehicles, fall from vehicle, high temperatures of product, etc.

It is the responsibility of the (un)loading sites to assess the risks of (un)loading operation and to determine the measures to be taken. They are dependent on the potential effect of the failure as well as the probability.

The risk can be product related, e.g. if the risk is an overflow of a tank the effects will be much more severe if the tank contains a very toxic material than if the tank contains water. Also the quantity of the product involved can play a role in the potential effect.

Examples of risk tables of products, split into different groups, to illustrate the potential different risks and measures that could be taken are found below

Reactive chemicals include those which are inherently unstable and susceptible to rapid decomposition as well as chemicals which, under specific conditions, can react alone, or with other substances in a violent uncontrolled manner, liberating heat, toxic gases, or leading to an explosion

Flammable liquids include products with a flashpoint of <60°C or in case the flashpoint is above 60°C handled with a temperature above the flashpoint.

Toxic liquids include products which are toxic for inhalation, exposure to skin or ingestion.

Other classified products which are all products classified according to dangerous goods legislation except the ones mentioned above.

Dry bulk, product that are solid particles and shipped in bulk silo's. For technical requirements of unloading facilities for dry bulk, see also [Guidelines for the Safe Tipping of Silo/Bulk/Containers and Tanks](#)

Non classified product, which are all the other products.

Please note that to define the risk of the product handled the product properties need to be reviewed.

The below tables give an impression of the possible technical measures than can be installed to mitigate the risk and also shows the possible relation to the product risks. The list is not mandatory to be applied. However it is mandatory to do a risk assessment and define for the specific situation what measures must be taken. Some measures are specifically mentioned in legislation in that case it is mandatory.

Abbreviation	Text	Interpretation
M	Mandatory (legislation)	Legal requirement
R	Recommended	Best practice
NtH	Nice to have	
NR	Not recommended	Advised NOT do to, can potentially increase risk.
NA	Not Applicable	

Measure	Product risk					
	Dry bulk not classified (ADR) Other Classified (ADR) Toxic (ADR Class 6.1) Flammable (ADR Class 3) Reactive chemicals					
<b>Overflow of transport tank/ silo and/or land tank/ silo</b>						
High Level Alarm in land tank/silo loading arm	R	M	M	R	R	R
High Level Switch in Land tank/loading arm interlocked with loading mechanism	R	M	M	R	R	
High level alarm/switch in transport tank/silo	NR	NR	NR	NR	NR	NR
Level indicator land tank/ silo	R	R	R	R	R	R
Flow meter on filling line	R	R	R	R	R	
Use of checklist to determine empty space in receiving tank/ silo. To be confirmed by filler and receiver.	R	R	R	R	R	R
Visual check on fluid level in Transport tank	NR	NR	NR	NR	NR	NR
<b>Pressure - overpressure and/or under pressure in transport tank/ silo and/or land tank / silo</b>						
(Un) loading process via pump and vapour return with check mechanism on flow (to prevent that eg vapour return valve is not open or line is blocked)	R	R	R	R	R	NA
The capacity of the vapour return line must be in line with the pump capacity.	M	M	M	M	M	NA
Double check of opening of vapour return valves	R	R	R	R	R	NA
Use of PVRV valves on land tank (the relief valves on transport tank are designed for temperature variations during transport)	R	R	R	R	R	NA
Unloading process via nitrogen pressure, with pressure relieve of transport tank via controlled vapour management system eg via land tank or scrubber	R	R	R	R	R	NA
<b>Exposure to vapours</b>						
Vapour return system for (un)loading	R	R	R	R	R	NA
Vapour release via vapour treatment system	R	R	R	R	R	NA
vapour released to atmosphere via vent of transport tank with use of PPE to prevent exposure to product based on instruction on MSDS	R	NR	NR	R	R	NA
Dedicated transport (via vapour return) vapour stays in tank	R	R	R	R	R	NA
<b>Fire / explosion(static electricity / reaction)</b>						
Earthing connection with safety to stop (un)loading when connection is not ok	NtH	R	NtH	NtH	NtH	R
Earthing connection with signal that the earthing is connected.	NtH	R	NtH	NtH	NtH	R
Earthing connection without signal	NtH	M	NtH	NtH	NtH	M
loading pipe close at the bottom of the tank to prevent building up of static electricity (in case of static accumulators)	NtH	M	NtH	NtH	NtH	NA
Connectivity of earthing points annually checked	NtH	M	NtH	NtH	NtH	M
Atex assessment	NtH	M	NtH	NtH	NtH	NtH
Vehicle earthing points in good condition and conductivity checked annually	NtH	M	NtH	NtH	NtH	M
Tank earth conductivity annually checked	NtH	M	NtH	NtH	NtH	M
Pipelines should be electrically conductive	NtH	M	NtH	NtH	NtH	M

Measure	Product risk					
	Dry bulk					
	not classified (ADR)					
	Other Classified (ADR)					
	Toxic (ADR Class 6.1)					
	Flammable (ADR Class 3)					
	Reactive chemicals					
<b>Contamination leading to reaction or unwanted mixture</b>						
dedicated (un)loading equipment	R	R	R	R	R	R
Dedicated vapour return lines	R	NtH	NtH	NtH	NtH	NA
Connection Marked with Product	R	R	R	R	R	R
Different connection type for each product, so it is not possible to mix connections	R	NtH	NtH	NtH	NtH	NtH
Tanks/ silo's Labelled product name and risks (GHS)	M	M	M	M	M	M
Dedicated tanks/ silo's	R	NtH	NtH	NtH	NtH	NtH
Visual Check to actively confirm equipment number with documentation control loading/unloading operation	R	R	R	R	R	R
Visual Check correct line-up of valves before starting loading/unloading	M	M	M	M	M	M
The measure is related to the risk?						
<b>Degassing of pressure after unloading under pressure</b>						
If vapour exist than via vapour treatment system	R	R	R	R	R	NA
Pressure release via land tank/silo, vapours of land tank treated.	R	R	R	R	R	R
Prevent by pump discharge and vapour return	R	R	R	R	R	NA
Degassing outside plant	NR	NR	NR	NR	NR	NR
<b>Unwanted movement of transport equipment</b>						
Wheel chock in use with connection to traffic light	All, and also for packed goods					
Two wheel chocks in use						
Driver out of cabin and keys out of contact (if engine is not needed for compressed air)						
Use of parking brakes during (un)loading						

Note 1) the best practice vent/vapour return connection size on transport equipment is 2 inch.  
Note 2) The pump design should take the capacity of the vapour vent of the transport tank into account. Pressure relief valves of transport equipment are not designed to cope with pump capacity. The lack of flow of the vapour return system needs to stop the pump.

Measures to risks related to packed material
Respecting segregation rules for stowing dangerous goods
Proper Forklift driver training to prevent damages to goods (punctured, fallen, etc), injuries etc.
Segregation rules for loading/ unloading (separate Forklift from truck driver) to prevent injury to driver
Fit NO- STACKING labels on pallets that cannot be stacked safely
Stacking rules displayed visually to prevent stacking too high
Protection bars to prevent damaging racks

Other measures related to (un)loading bulk
Presence of a system to generate an alarm
Emergency button that stops the loading process at a location that can be reached (e.g. in case of spill/ fire.)
Safety shower (linked to alarm)
Eye wash shower

## 7.2. Examples of risk mitigation for non-standard operations

---

The HSE management system should consider all risks; it should contain all operations and the associated hazards. Enabling an organization to include all developments, changes and deviations from standard operations on a continuous basis, it is necessary to have a system in place to formally assess and address these situations.

A 'standard delivery' to customer site for chemical products in bulk is characterized as follows:

- Agreed carrier, loading and delivery dates, product volume and loading location.
- Carrier equipment is in line with common agreed practice and fits the order.
- Appropriate shipping documents are present and no additional product handling during loading, transit or unloading is taking place (e.g. no local ad-hoc filtering or trans-loading into other truck / equipment).
- Discharge fully at the agreed and known customer unloading location without return of product.
- Unloading takes place in a bulk land tank.
- No disruption after the discharge has started.
- Agreed pressures, nitrogen blanketing and temperatures in the transport vessels in line with product requirements and common practice, before and after (un)loading.

An operation that is different from the definition of 'standard' described above is 'non-standard operation (NSO)'. Suppliers and carriers should proactively monitor these NSO's and make sure to evaluate the operational risks. NSO's increase the likelihood of errors and incidents and could place drivers, operators or the environment at risk. Therefore it is necessary to carry out risk analysis and to either eliminate any NSO or to manage the risk to an acceptable low level. Giving continuous developments, changes and deviations of processes, it is not possible to make an extensive NSO list.

However regularly occurring NSO's have been identified with suggested control mechanisms as listed below:

- Unloading into drums and IBC and directly into containers.
- Insufficient capacity of the storage tank
- Unloading into multiple tanks or incomplete unloading
- Drop off / parking of containers
- Trans-loading between containers
- Adding additives directly in to the transport vessel.

Carriers are encouraged to report NSO and / or potentially unsafe situations to the supplying chemical company. If a driver is in doubt whether the unloading operation can be done safely, he should not commence discharging and contact his planning department who can subsequently ask support from the supplier.

Below are three examples on how to handle non-standard operations that can be used to benchmark internal processes. Companies can have different approaches to mitigate the risk, but the goal is always no harm to people, environment and assets.

### 7.2.1. Direct Discharge from Bulk Equipment into IBC or Drums

---

The potential health, safety and environmental risks involved in unloading from bulk equipment directly into drums or Intermediate Bulk Containers (IBCs) without using a fixed installation are:

- Loss of containment of product resulting from leakage, human error, malfunction of equipment or overfilling.
- Human exposure and a potential for serious injury.

- In the case of flammable products, there are known cases where fire or explosion during this operation led to multiple fatalities and/or major asset damage to customer facilities or logistics equipment.
- In case of products used in the food, feed, cosmetic and pharmaceutical industry (Glycol Propylene glycol fatty acids etc.) there is risk of contamination of the product itself. In turn it has a potential impact on the human health of the consumers of this product.

For the reasons mentioned above it is strongly recommended not to directly unload from the bulk equipment with a hose directly into a drum or IBC. To unload into drums or IBCs safely, a fixed filling installation must be available.

‘Fixed’ means that an installation is equipped with a fixed discharge connection. The driver and customer operator can connect the hose directly to the manifold of the filling installation and the truck can be discharged without interruption (essentially, no different in operation compared to discharge to a storage tank). Obviously the product should always be handled in accordance with the Safety Data Sheet requirements (e.g. use appropriate Personal Protective Equipment).

The driver is not in charge of assessing a fixed drum / IBC installation!

If the driver can connect to a fixed installation at the customer site without any additional actions by himself compared to a normal discharge into a storage tank, he should only mention this situation to his planner who subsequently informs the supplier. If the intention is to directly discharge into IBCs from the tanker without a fixed installation, he should not start and contact his planning department who will get support from the supplier.

Product related requirements matrix:

Requirements for drum or IBC filling installation		Non flammable, non toxic		
		Flammable Product		
		Toxic product		
1	The filling process is controlled and avoids product overflow and spill. Secondary containment is available	X	X	X
2	The driver is not involved in the drum or IBC filling operation.	X	X	X
3	A fume collection system removes vapours during filling of drums or IBCs	X	X	
4	Ignition sources in the filling area are avoided by using suitable electrical equipment, measures to avoid sparks, naked flame, etc.		X	
5	Static electricity during filling is avoided by <ul style="list-style-type: none"> <li>- Earthing or metal drums or IBCs</li> <li>- Using a filling lance which is earthed and reaches the bottom of the drum of IBC.</li> </ul>		X	

### 7.2.2. Unloading into more than one Storage Tank or incomplete Unloading

Discharge into more than one storage tank is allowed if the unloading hose is connected to a single manifold leading to multiple storage tanks and the hose is not disconnected during the unloading operation.

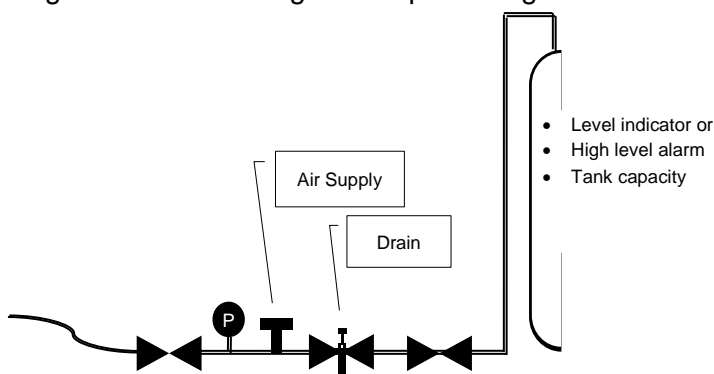

For those situations where delivery goes into more than one storage tank and the discharge hose must be disconnected during unloading, the hose or customer’s installation should be equipped with a device to safely empty the contents of the hose after the first discharge. This can be done by means of an adaptor fitted with an air valve for non-flammable products/ nitrogen valve for flammable products between the unloading hose and the

customer's inlet connection (see illustration). Note how the adaptor allows the hose to be flushed back into the transport tank before it is connected to the next storage tank. This operation should be carried out by the customer with properly trained operators and technical equipment without exposing the driver to any risks.

### 7.2.3. Insufficient Capacity of Storage Tank

The customer should proactively confirm to the driver that there is sufficient free space in the receiving storage tank prior start of discharge. If for any reason the discharge cannot be completed then the truck driver should wait until there is enough space in the receiving customer's tank to resume the discharge operation safely. If this is not possible within a realistic timeframe and the truck cannot be completely unloaded, this should be recorded in the remark field of the transport document and the supplier should be informed accordingly. Ideally, handling of the hose should be done as described in the paragraph Unloading into more than one Storage tank or incomplete loading and the incident should be recorded by the parties involved. Any partially loaded vehicles embarking on a return trip to the supplier should comply with the '80/20 rule'

## 8. Annex 8: (Un)loading expressions / list in English

For bi-lingual reference see [www.transperanto.org](http://www.transperanto.org)

Language lists are in English, Dutch, German, French, Italian, Spanish, Portuguese, Polish, Russian (Phonetic + Cyrillic), Romanian, Bulgarian (Phonetic + Cyrillic), Turkish, Hungarian, Czech, Slovak, Slovene, Croatian, Serbian, Swedish, Danish, Norwegian, Finnish, Latvian, Estonian, Lithuanian, Greek (Phonetic + Greek)

Gate house check	Emergency	General	Loading Bulk
D.1 ADR certificate	E.1 All safe	G.1 Dangerous Goods	LB.1 Are all the outlets closed ?
D.2 Border	E.2 Assembly Point	G.2 Driver	LB.2 Bottom valve
D.3 Call your boss	E.3 Emergency Drill	G.3 Open	LB.3 Safety valve
D.4 No entry	E.4 Emergency situation	G.4 Closed	LB.4 Cleaning document
D.5 Fill in the paper	E.5 Follow	G.5 No	LB.5 Compartment
D.6 Means of Identification	E.6 Evacuation	G.6 Yes	LB.6 Compartment size
D.7 Licence/Number plate	E.7 Alarm signal	G.7 Damaged	LB.7 Compressor
D.8 Invoice	E.8 Gas alarm	G.8 Not OK	LB.8 Pump
D.9 Loading papers	E.9 Absorbant material	G.9 OK	LB.9 Connect
D.10 Shipment number	E.10 Broom	G.10 Go to	LB.10 Disconnect
D.11 Signature	E.11 Spade	G.11 Loading place	LB.11 Contaminated
D.12 Tremcard equipment	E.12 First Aid	G.12 Left	LB.12 Coupling
D.13 Fire extinguisher	E.13 Medical Centre	G.13 Right	LB.13 Depressurize
D.14 Lights		G.14 Stay here	LB.14 Earthing connection
D.15 Tyres		G.15 Straight on	LB.15 Emergency stop
D.16 Tomorrow		G.16 Start	LB.16 Filling degree
D.17 Too Early		G.17 Stop	LB.17 Filter
D.18 Too Late		G.18 Wait	LB.18 Gasket
D.19 Weigh ticket		G.19 Park here	LB.19 Hose
D.20 Seal		G.20 Parking place	LB.20 Manhole
D.21 Intercom		G.21 Weighbridge	LB.21 Baffles / Surge plates
		G.22 Safe	LB.22 Flange
		G.23 Unsafe	LB.23 Pressure test
		G.24 Tired	LB.24 Overfill protection
		G.25 Problem	LB.25 Nitrogen
		G.26 Papers	LB.26 Air
			LB.27 Vacuum
			LB.28 Vapour return
			LB.29 Sample
			LB.30 Not clean/dirty
			LB.31 Out of spec
			LB.32 Spill
			LB.33 Storage tank
			LB.34 Tank
			LB.35 Tank container ID plate
			LB.36 Labels



Loading General	Loading Packed	Safety
LG.1 Load	LP.1 Secure the load	S.1 Speed limit < 20/30 km/hr
LG.2 Unload / Discharge	LP.2 Blocking material	S.2 No smoking
LG.3 Container	LP.3 Bracing	S.3 No mobile phones
LG.4 Container CSC plate	LP.4 Double stacking	S.4 No alcohol
LG.5 Truck	LP.5 Free space	S.5 No photographs
LG.6 Axle weight	LP.6 Lashing straps	S.6 No passengers
LG.7 Tare weight (empty weight)	LP.7 Curtain	S.7 No animals
LG.8 Fall protection	LP.8 Load floor	S.8 Wear Safety Glasses
LG.9 Harness	LP.9 Load plan	S.9 Wear protective clothing
LG.10 No climbing	LP.10 Trailer	S.10 Wear helmet
LG.11 Finished		S.11 Wear safety shoes
LG.12 Kilograms		S.12 Wear gloves
LG.13 Quantity to be loaded		S.13 Safety shower
LG.14 Max total weight		S.14 Eye wash
LG.15 Not enough		S.15 Safety Instructions
LG.16 Too much		
LG.17 Product not ready		
LG.18 Stay at your vehicle		
LG.19 Switch off engine		
LG.20 Placarding		
LG.21 Wheel chocks		



## 9. Annex 9: Examples of pictographic loading instructions

To ensure the instructions given to the driver are understood the set of expressions in [Annex 8: \(Un\)loading expressions / list in English](#) might not be sufficient. Rather than issuing procedures in full text format pictograms, pictures or cartoons can be used.

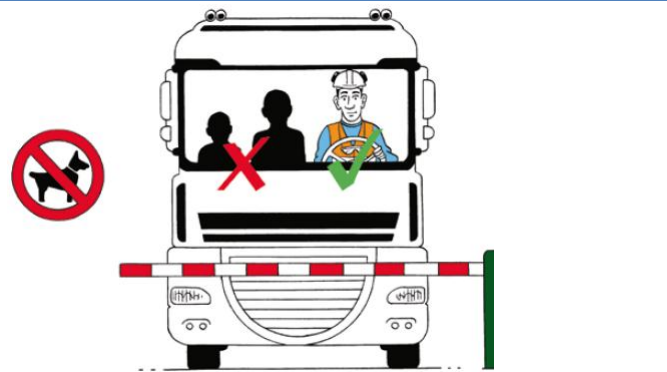
### 9.1. Examples of Pictographic loading rules

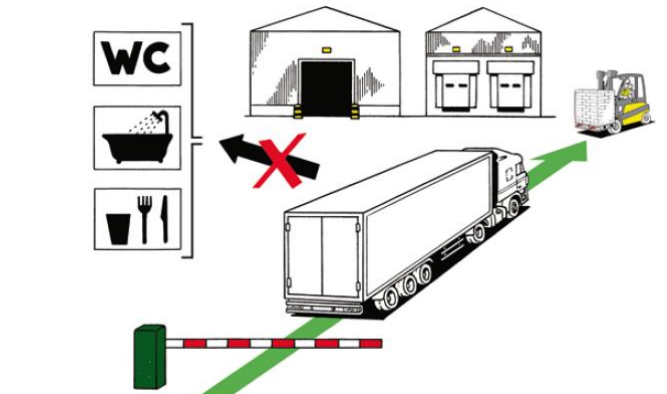
Text	Cartoon
<p>Whilst on the site, drivers must wear a safety hat, safety shoes, high visibility vest, gloves and working clothes that fully cover arms and legs at all times.                      Wear ear protection and safety goggles where indicated.                      Safety harness/fall protection must be used in the loading area.</p>	
	<p>You are strictly prohibited from taking unauthorised persons as well as animals onto the site.</p>
<p>In the event of an alarm: immediately follow the instructions from Site personnel.</p>	
	<p>After entering the site, you must proceed immediately and direct to the loading location.</p>

## 9.2. Examples of Pictographic loading rules for packed

Text	Cartoon
<p>At the loading location: switch off the engine. Pull the hand-brake. Open trailer completely on one side. Only use the movable stairs provided by Site, in locked position.</p>	
	<p>Stay visibly in the cabine or on the green marked spot whenever a fork lift truck is within 5 metres from the lorry/trailer.</p>

## 9.3. Examples of Pictographic loading rules for Bulk Solids

Text	Cartoon
<p>Only open 1 filling hatch at the time. In order to prevent contamination, close the hatch immediately after filling.</p>	
	<p>To step on the container, use the ladder that is provided and return it to the designated place after use.</p>
<p>All work on the container must only take place in the bulk lane.</p>	